



**TELEDYNE**  
**OLDHAM SIMTRONICS**  
Everywhereyoulook™

# USER MANUAL

## OLC/OLCT100

GAS DETECTOR



# OLC/OLCT100

GAS DETECTOR  
USER MANUAL

User Manuals in other languages are available on  
Website <https://teledynegasandflamedetection.com>



Copyright © June 2024 by TELEDYNE OLDHAM SIMTRONICS S.A.S.

All rights reserved. No reproduction of all or part of this document, in any form, is permitted without the written consent of TELEDYNE OLDHAM SIMTRONICS S.A.S.

All of the information that is provided in this document is accurate to the best of our knowledge.

As a result of continuous research and development, the specifications of this product may be changed without prior notice.

TELEDYNE OLDHAM SIMTRONICS S.A.S.

Rue Orfila

Z.I. Est – CS 20417

62027 ARRAS Cedex

Thank you for choosing this TELEDYNE OLDHAM SIMTRONICS instrument.

All of the necessary actions have been taken in order to ensure your complete satisfaction with this equipment.

It is important that you read this entire manual carefully and thoroughly.

## The extent of our responsibility

●The company TELEDYNE OLDHAM SIMTRONICS S.A.S., hereinafter referred to as TELEDYNE OLDHAM SIMTRONICS throughout this document, shall not be held responsible for any damage to the equipment or for any physical injury or death resulting in whole or in part from the inappropriate use, installation, or storage of the equipment, which is the result of not complying with the instructions and warnings, and/or with the standards and regulations in force.

TELEDYNE OLDHAM SIMTRONICS does not support or authorise any business, person, or legal entity in assuming responsibility on behalf of TELEDYNE OLDHAM SIMTRONICS, even though they may be involved in the sale of TELEDYNE OLDHAM SIMTRONICS products.

TELEDYNE OLDHAM SIMTRONICS shall not be responsible for any damage, direct or indirect, or for damages and interest, direct or indirect, resulting from the sale and use of any of its products **UNLESS SUCH PRODUCTS HAVE BEEN DEFINED AND CHOSEN BY TELEDYNE OLDHAM SIMTRONICS FOR THE USE THAT THEY ARE INTENDED.**

## Ownership clauses

●The drawings, specifications, and information herein contain confidential information that is the property of TELEDYNE OLDHAM SIMTRONICS.

●This information shall not, either in whole or in part, by physical, electronic, or any other means whatsoever, be reproduced, copied, divulged, translated, or used as the basis for the manufacture or sale of TELEDYNE OLDHAM SIMTRONICS equipment, or for any other reason **without the prior consent of TELEDYNE OLDHAM SIMTRONICS.**

## Warning

This is not a contractual document. In the best interest of its customers and with the aim of improving performance, **TELEDYNE OLDHAM SIMTRONICS** reserves the right to alter the technical features of its equipment without prior notice.

**READ THESE INSTRUCTIONS CAREFULLY BEFORE THE FIRST USAGE:** these instructions should be read by all persons who have or will have responsibility for the use, maintenance, or repair of the instrument.

This instrument shall only be deemed to be in conformance with the published performance if used, maintained, and repaired in accordance with the instructions of TELEDYNE OLDHAM SIMTRONICS by TELEDYNE OLDHAM SIMTRONICS personnel or by personnel authorised by TELEDYNE OLDHAM SIMTRONICS.

## Important Information

The modification of the material and the use of parts of an unspecified origin shall entail the cancellation of any form of warranty.

The use of the unit has been projected for the applications specified in the technical characteristics. Exceeding the indicated values cannot in any case be authorized.

Catalytic sensors are susceptible to poisoning by traces of several substances. This leads to an inhibition which can be permanent or temporary depending on the contaminant, the concentration of the contaminant, the duration of exposure to the contaminant.

Poisoning may result from exposure to substances as:

- Silicones (e.g. Waterproofing, adhesives, release agents, special oils and greases, certain medical products, commercial cleaning agents)
- Tetraethyl lead (e.g. Leaded petrol, particularly aviation petrol 'avgas')
- Sulfur compounds (sulfur dioxide, hydrogen sulfide)
- Halogenated compounds (r134a, hfo, etc.)
- Organo-phosphorus compounds (e.g. Herbicides, insecticides, and phosphate esters in fireproof hydraulic fluids)

TELEDYNE OLDHAM SIMTRONICS recommends regular testing of fixed gas detection installations (read Chapter 5).

## Guarantee

Under normal conditions of use and on return to the factory, parts and workmanship are guaranteed for 3 years, excluding such consumables as sensors, filters, etc.

## Destruction of the equipment



**European Union (and EEA) only.** This symbol indicates that, in conformity with directive DEEE (2002/96/CE) and according to local regulations, this product may not be discarded together with household waste.

It must be disposed of in a collection area that is set aside for this purpose, for example at a site that is officially designated for the recycling of electrical and electronic equipment (EEE) or a point of exchange for authorized products in the event of the acquisition of a new product of the same type as before.

# Table of Contents

<b>1</b>	<b>Presentation.....</b>	<b>7</b>
1.1	Purpose.....	7
1.2	Operating principle.....	7
1.3	Composition of the detector.....	7
1.4	Internal elements.....	8
1.5	Identifiers.....	9
<b>2</b>	<b>Ranges.....</b>	<b>11</b>
2.1	OLC 100 and OLCT 100 ranges.....	11
<b>3</b>	<b>Installation.....</b>	<b>13</b>
3.1	Regulations and conditions of use.....	13
3.2	Necessary equipment.....	13
3.3	Electrical power supply.....	14
3.4	Location of the detector.....	14
3.5	Detector positioning.....	14
3.6	Connector cable.....	15
3.7	Cable connection.....	17
<b>4</b>	<b>Calibration.....</b>	<b>21</b>
4.1	Necessary equipment.....	21
4.2	Commissioning.....	21
4.3	Warm-up time.....	22
4.4	Calibrating the OLC 100.....	23
4.5	Calibrating the OLCT 100.....	24
<b>5</b>	<b>Preventive maintenance.....</b>	<b>31</b>
5.1	Frequency of maintenance.....	31
5.2	Actions.....	32
<b>6</b>	<b>Maintenance.....</b>	<b>33</b>
6.1	Opening the cover.....	33
6.2	Checking the current generator.....	34

6.3	Possible errors .....	35
6.4	Replacing sensor block.....	36
<b>7</b>	<b>Accessories .....</b>	<b>39</b>
7.1	Cable gland .....	42
<b>8</b>	<b>Spare parts .....</b>	<b>43</b>
<b>9</b>	<b>Technical specifications .....</b>	<b>47</b>
9.1	Dimensional characteristics .....	47
9.2	General Specifications.....	48
9.3	Catalytic sensor (OLCT 100 XP) .....	51
9.4	Toxic sensors (OLCT 100 XP and OLCT 100 IS) .....	52
9.5	Semiconductor sensors (OLCT 100 XP).....	54
9.6	Infrared sensors (OLCT 100 XP-IR) .....	55
9.7	MEMS sensors (OLCT 100 XP) .....	56
<b>10</b>	<b>Specific instructions for use in explosive atmospheres and operational safety .....</b>	<b>59</b>
10.1	General comments .....	59
10.2	Cable Entries .....	59
10.3	Threaded joints .....	60
10.4	Electrostatic Hazard .....	60
10.5	Metrological performance for the detection of flammable gases 60	
10.6	Specific Conditions of Use .....	61
10.7	Specific Conditions of Use for FM.....	61
10.8	Specific Conditions of use for CSA .....	61
10.9	Installation Drawing for OLCT100IS .....	64
10.10	Scope of use.....	65
10.11	Functional safety .....	65
10.12	Reliability data.....	66
10.13	Special conditions of use .....	66
<b>11</b>	<b>Appendix Ordering information .....</b>	<b>67</b>
11.1	Gas List.....	67

# 1 Presentation

## 1.1 Purpose

This range of sensors is designed to detect a particular gas depending on the type of sensor used.

## 1.2 Operating principle

The measurement sensor converts the target gas into voltage or current. This electrical parameter is:

- Either conducted directly via a connecting cable to a dedicated central measurement unit (as with the OLC 100 explosimeter) that operates on the principle of the Wheatstone bridge. Such a measurement unit is available in the TELEDYNE OLDHAM SIMTRONICS range.
- Or amplified, corrected for temperature, linearised, and converted to a 4-20 ma signal (as for the OLCT 100) and conducted via a connecting cable to a centralized unit (measurement unit or industrial automation system).

## 1.3 Composition of the detector

A detector comprises the following elements:

Id.	Description
1.	Company label
2.	Cover
3.	PCB protector (for OLCT version).
4.	PCB.
5.	Cable gland inlet. (cable gland not supplied).
6.	Enclosure.
7.	Sensor block.
8.	Nozzle.
9.	Ground connection.
10.	LEL sensor (high temperature).

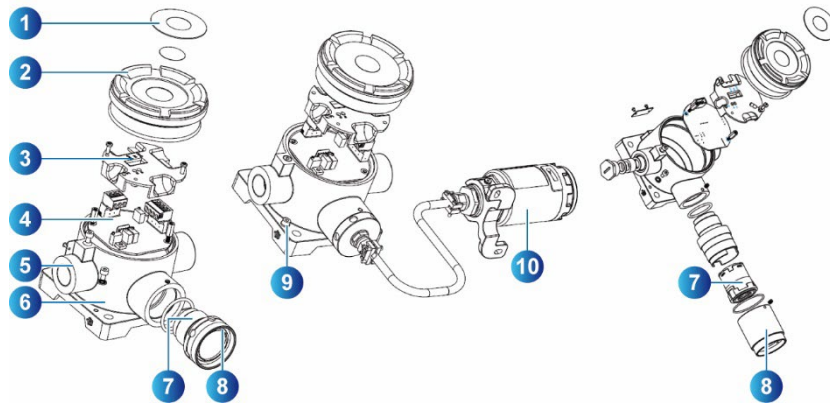
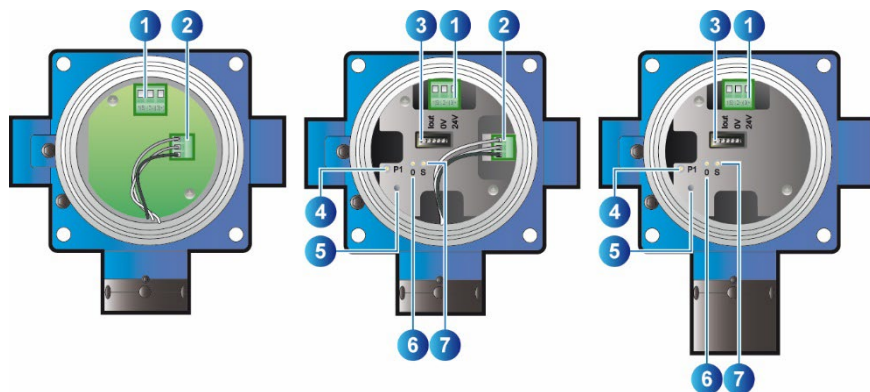

Figure 1 : component parts of an OLCT 100 detector

## 1.4 Internal elements

The following elements are internally accessible to the user:

Id.	Description
1.	Terminal for the cable being connected to the controller (measurement unit, automation).
2.	Sensor block connector.
3.	Calibration ribbon connector.
4.	4 mA adjustment.
5.	Push button access for 4 mA adjustment.
6.	Zeroing.
7.	Sensitivity adjustment.



*OLC 100 detector*

*OLCT 100 explosimeter*

*OLCT 100 detector for toxic gases*

Figure 2 : internal view of the detectors



## 1.5 Identifiers

The enclosure has two identifier labels, as described below:

### 1.5.1 Company label

This in turn groups the detector features together:

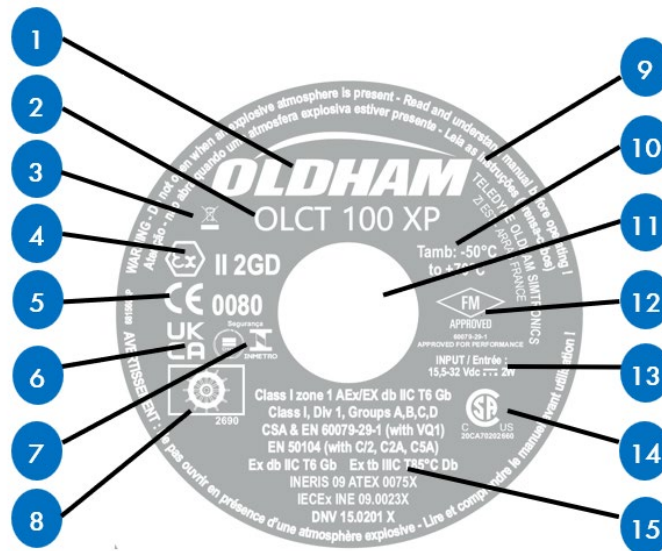

Id.	Description
1.	Name and address of the Manufacturer
2.	Name of product
3.	Recycling symbol
4.	ATEX Marking
5.	CE symbol and the number of the organisation that provided the TELEDYNE OLDHAM SIMTRONICS production quality certification (INERIS)
6.	UKCA Marking
7.	INMETRO Marking
8.	Symbol of Marine Certification and number of the Approval Agency that issued the certificate
9.	Warnings
10.	Temperature range for which the detector is certified for use in explosive areas (excluding metrological performance)
11.	Type of gas detected and range of measurement
12.	FM Marking

Id.	Description
13.	Power supply type
14.	CSA Marking
15.	Additional markings ATEX, IECEX, INMETRO, etc and numbers of certificates

## 1.5.2 Side label

This label shows the following :

Id.	Description
1.	Thread diameter and pitch for cable inlet
2.	Detector reference number (P/N)
3.	Detector serial number (S/N)  The first two digits (in this case 09) correspond to the year of manufacture (in this case 2009)

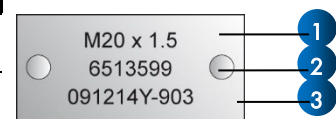

Figure 3 : side label

## 2 Ranges

### 2.1 OLC 100 and OLCT 100 ranges

The OLC 100 range is reserved for the detection of explosive vapor by using a Wheatstone bridge sensor.

The OLCT 100 range of detectors is provided with an amplifier producing a 2 or 3 wire 4-20 mA analog output. These are transmitter detectors and, therefore, the letter "T".

	OLC 100	OLCT 100 XP	OLCT 100 XPIR	OLCT 100 IS	OLCT 100 HT
Features	Explosion proof	Explosionproof	Explosionproof	Intrinsically safe (1)	Explosionproof (2)
Detection of explosive gases	Catalytic sensor (VQ1)	Catalytic sensor (VQ1 or AP 4F) or semi-conductor or MEMS	Infrared sensor	✗	Catalytic sensor high temperature
Detection of toxic gases	✗	EC Or SC	Infrared sensor	EC	✗
Detection of oxygen	✗	EC	✗	EC	✗
Detection of CO <sub>2</sub>	✗	✗	Infrared sensor	✗	✗
4-20 mA output	✗ (3)	2 wires for EC 3 wires for SC, CAT, MEMS	3 wires	2 wires	3 wires

(1) Requires the use of a Zener barrier

(2) Sensor can be remote up to 5, 10, or 15 meters using a high temperature cable

(3) mV bridge output, 3 wires

EC : Electrochemical sensor

SC : Semi-conductor sensor.

CAT : Catalytic bead

AP : Poison resistant

MEMS: Micro-Electro Mechanical Systems, thermal conductivity technology

**Table 1 : comparison of OLC 100 and OLCT 100 series detectors**

# OLC/OLCT100

GAS DETECTOR  
USER MANUAL

## 3 Installation



---

It is recommended that the guides relating to the installation, use, and maintenance of flammable gas and oxygen detectors (standard EN/IEC 60079-29-2) and toxic gas detectors (standard EN 45544-4) should be clearly understood.

Installation shall be in accordance with the standards in force, classification of the zone, and in conformity with standards EN/IEC 60079-14 and EN/IEC 61241-14, the editions in force, or with other national and/or local standards.

---

### 3.1 Regulations and conditions of use

- The installation should meet all the regulations currently in force for installations in explosive atmospheres, in particular the standards IEC/EN 60079-14 and IEC/EN 60079-17 (whichever editions are in force) or in accordance with other national standards.
- Generally speaking, the ambient temperature, supply voltage, and power that are mentioned in this document relate to explosion safety. **This has nothing to do with the operating temperatures of the detector.**
- The equipment is allowed in zones 0, 1, 2, 20, 21 and 22 for ambient temperatures ranging from -40 ° C to + 70 °.
- The detector sensor in the transmitter should always be in contact with the ambient air. Therefore:
  - Do not cover the detector.
  - Do not paint the detector.
  - Avoid dust.

### 3.2 Necessary equipment

- Complete detector assembly
- Requisite connector cable
- Multimeter (intrinsically safe, if necessary)
- Tools
- Fixing hardware

### 3.3 Electrical power supply

Type of detector	Supply (V DC)	Maximum current (mA)	Power consumed (mW)
OLCT 100 XP HT	15,5 to 32	110	1705
OLCT 100 XP CAT	15,5 to 32	100	1550
OLCT 100 XPIR	15,5 to 32	80	930
OLCT 100 XP EC	11 to 32	23,5	260
OLCT 100 IS EC	11 to 32	23,5	260
OLCT 100 XP SC	15,5 to 32	100	1550
OLCT 100 XP MEMS	15,5 to 32	30	465
OLC 100 (VQ1)	By TELEDYNE OLDHAM SIMTRONICS controller	340	(1)
OLC 100 (4F)	By TELEDYNE OLDHAM SIMTRONICS controller	370	(1)

(1) Depends on the gas controller

### 3.4 Location of the detector

Depending on the density of the gas to be detected or the application, the detector shall be positioned at the ground level, or on the ceiling at the same height as the airflow, or near to the air extraction ducts. Heavy gases may be detected at the ground level, while light gases will be found at ceiling height. Gas densities are provided on page 28.

### 3.5 Detector positioning

The detector shall be installed with the detector sensor pointing downwards.

Any tilt of more than 45° from the vertical will lead to an inaccurate measurement.

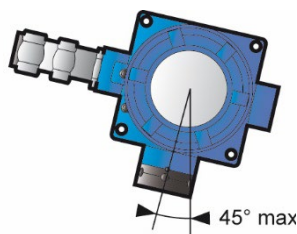

Figure 4 : sensor pointing downwards and maximum tilt angle

Installation of the enclosure shall be secured with 4 x M6 screws and the appropriate plugs for the supporting material

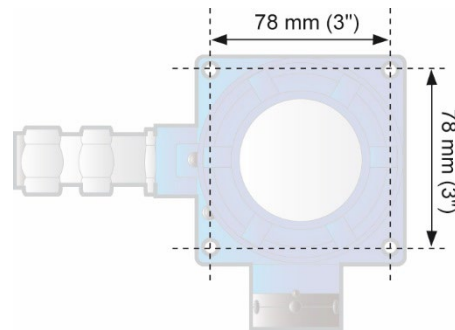

Figure 5 : fixing template for the enclosure

A special holder is available for mounting the detector on the ceiling (see section on accessories.

In the OLCT 100 HT version, only the removable detector head can be used at temperatures from  $-20^{\circ}\text{C}$  to  $+200^{\circ}\text{C}$ . The OLCT 100 HT enclosure can only be used in ambient temperatures from  $-40^{\circ}\text{C}$  to  $+70^{\circ}\text{C}$ . The high temperature cable between the OLCT 100 HT enclosure and the head is integral with the instrument and is not user-replaceable.

The cable should be protected mechanically

### 3.6 Connector cable

The detector shall be connected to the controller (measurement and automation unit) by a shielded instrumentation cable, armoured when necessary. The choice of cable will be dictated by the particular requirements of the installation, distance, and type of detector (see table below).

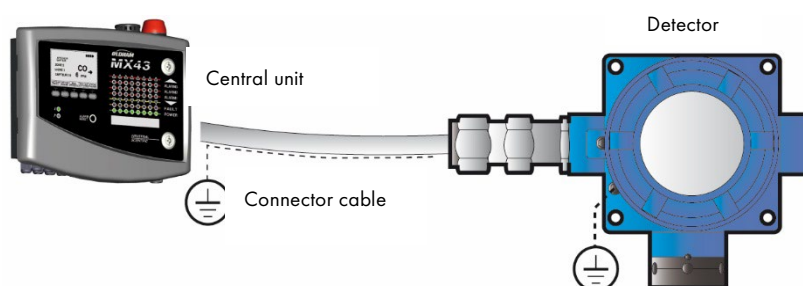

Figure 6: the cable connecting the detector to the controller should be chosen with care

Type of detector	Type of sensor	Maximum length (km) for cable of cross-section as indicated			Maximum load resistance for 4-20 Ma
		0,5 mm <sup>2</sup>	0,9 mm <sup>2</sup>	1,5 mm <sup>2</sup>	
Upstream line voltage (V <sub>cc</sub> )		24	24	24	
OLCT 100 XP	Catalytic or semiconductor	0.8	1.4	2.4	250
OLCT 100 XP	MEMS	1.6	3	4.4	250
OLCT 100 XP (1)	Electrochemical	<4	<4	4.4	250
OLCT 100 XPIR	Infra-red	1.4	2.6	4.4	250
OLCT 100 IS (2)	Electrochemical	1.8	3.3	4.4	250
OLCT 100 HT	Catalytic, high temperature	0.8	1.4	2.4	250

(1) for resistance calculations, the assumed load is 120  $\Omega$  for 4-20 Ma.

(2) for resistance calculations, the assumed load is 120  $\Omega$  for 4-20 Ma, and a 300  $\Omega$  Zener blocking diode.

Warning: all wiring should meet the installation standards and should be described in a system document for SI installations.

The cable must have a braided screen to reduce the influence of electrical and radio-frequency interference. A cable such as AFNOR M 87-202 01-IT-09-EG-FA (Nexans) may be used. It shall be selected according to the type of detector and in accordance with the table shown hereinabove. Below are further examples of suitable cables:

Non ATEX zone: CNOMO FRN05 VC4V5-F

ATEX zone: GEUELYON (U 1000RHC1)

ATEX zone: GVCSTV RH (U 1000)

ATEX zone: xx-xx-09/15- EG-SF or EG-FA or EG-PF (U 300 compatible with M87202)

The maximum permissible length will depend on the cross-section of the cable conductors (see table) and on the minimum supply voltage.



## 3.7 Cable connection

### 3.7.1 Switch off line power supply

On the controller:

1. Inhibit any installation alarms to avoid unexpected triggering during operation.
2. In accordance with the manufacturer's instructions, switch off the power to the module in order to be connected to the detector.

### 3.7.2 Cable preparation

The cable shall be taken from the controller (measurement and automation) to the point of measurement (see Figure 8). The passage, support, and protection of the cable shall be according to best practice.

### 3.7.3 Cable entry

---

The detector is supplied without cable gland.



It is essential that the instructions provided by the manufacturer of the compression gland are followed and the braided screen is correctly connected. M20x1.5 flame proof certified cable gland shall be used (see Chapter 11).

---

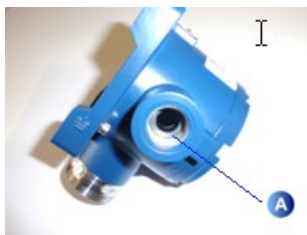

- 1 - Remove the gasket and the two metal washers (Rep A) supplied with the detector.

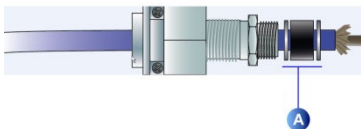

- 2 - Arrange the cable as shown in the picture.



- 3 - Spread the braided shield as shown in the picture.  
Avoid creating "pigtailed" with the braided shield.

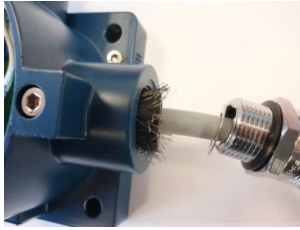

4 - Insert the part back into the OLC/OLCT100 and then mount the cable gland (not supplied).

## 3.7.4 Cable connection



The connection of the cable between the detector and controller should be made with the power off. The site should be at equal potential

Connect the cable to the detector side before connecting the controller side.

After the wiring has been completed, connect the cable screen to the ground terminal of the controller.

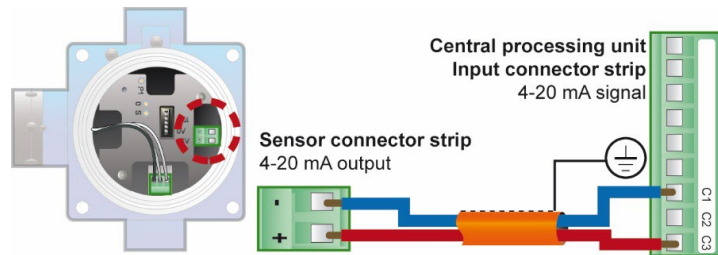

Figure 7: connection for a 2-wire 4-20 Ma detector

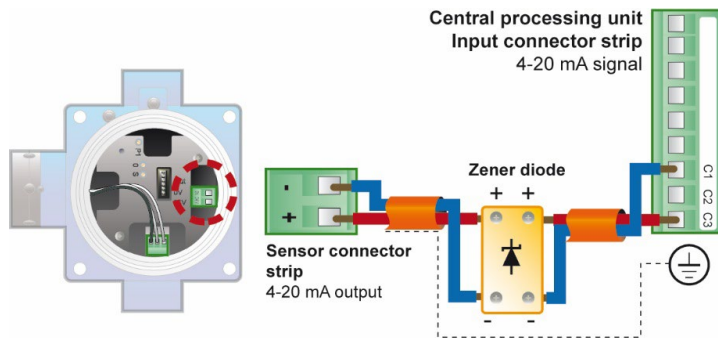

Figure 8: connection for an intrinsically safe, 2-wire 4-20 Ma detector with a Zener diode

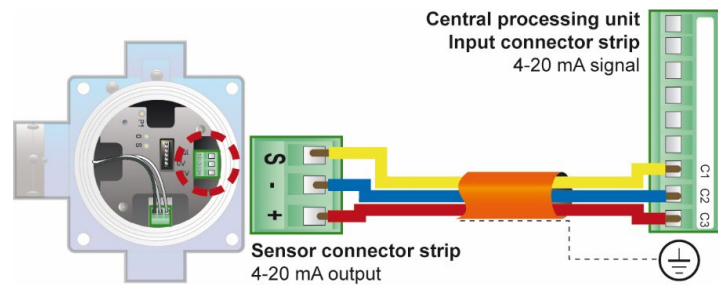

Figure 9: connection for a 3-wire 4-20 Ma detector

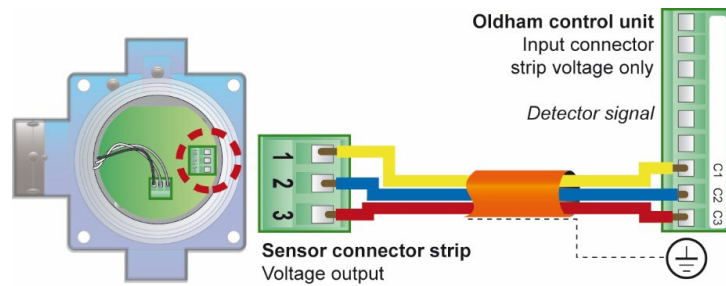

Figure 10: connection for a 3-wire OLC 100 type detector

### 3.7.5 Connecting the enclosure to ground

Connect the enclosure ground terminal to earth according to the regulations. This ground connection may, however, be taken from the terminal on the screw fixing the PCB to the inside of the housing.

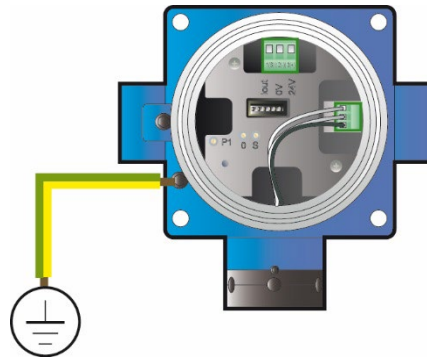

Figure 11 : Ground connection terminal

### 3.7.6 Closing the cover

Before connecting the cable to the terminal on the controller, it is essential that the cover is completely closed.



In order to lock the cover by rotation, unscrew the blocking screw until into contact with the cover.

If you were to remove the cover, tighten the blocking screw before unscrewing the cover.

Cover blocking screw

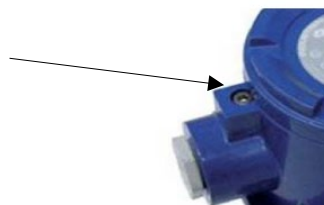

# **OLC/OLCT100**

GAS DETECTOR  
USER MANUAL

## 4 Calibration



The tasks described in this chapter are reserved for authorised trained personnel only, since these tasks are liable to affect detection reliability

This procedure describes:

- Zero adjustment;
- Sensitivity adjustment.

### 4.1 Necessary equipment

- Multimeter (ranges 0-30 mA and 0-2 V), intrinsically safe if necessary.
- Cylinder of pure air.
- Cylinder of calibration gas, of suitable concentration for the measurement range (between 30 and 70% of the measurement range).

### 4.2 Commissioning

#### 4.2.1 Prior checks

Check the following points:

- Detector housing grounded.
- Connexion of the shielding of the cable and the ground to the controller
- Integrity of the mechanical mounting (fixings, cable gland, and cover) ensured.

#### Powering up detector

1. Inhibit any installation alarms to avoid unexpected triggering during the operation.
2. Connect power to the detector line in accordance with the manufacturer's instructions.

## 4.3 Warm-up time

---



When powered up or after a sensor replacement, a warm-up period is needed before performing a calibration.

- Catalytic technology: 2 hours
  - Electrochemical technology for Oxygen: 1 hour (2 year sensor) to 1.5 hour (5 year sensor)
  - Electrochemical technology for Toxic gases: 1 hour, excluding:
    - NO (nitrogen monoxide): 12 hours
    - HCl (hydrogen chloride): 24 hours
    - ETO (ethylene oxide): 36 hours
    - CH<sub>2</sub>O (formaldehyde): 36 hours
  - Semiconductor technology: 4 hours
  - Infra-red technology: 2 hours
  - **MEMS technology: 2 hours**
- 



**Specific conditions for powering up the OLCT 100 with MEMS sensor:**

OLCT100 XP MEMS must be powered up under thermal conductivity similar to those of the gas mixture in which it will be used. For use in the open air, the OLCT100 XP MEMS must be powered up in ambient air.

The gas concentration, expressed on the analog output, is available 2 minutes after the OLCT100 XP is switched on.

We recommend checking that there are no flammable gases in the atmosphere before powering up the OLCT100 XP MEMS.

If there is any uncertainty as to the absence of flammable gas in the environment, it is advisable to power up the OLCT100-XP-MS by injecting reconstituted synthetic air (78.2% Vol. N<sub>2</sub>, 20.9% Vol. O<sub>2</sub>, 0.9% Vol. Ar) or the following mixture (82% Vol. N<sub>2</sub>, 18% Vol. O<sub>2</sub>) from a titrated gas bottle.

Diffusion of the titrated gases must take place before the OLCT100 XP MEMS is switched on and continue for 2 minutes after start-up.

---

## 4.4 Calibrating the OLC 100



The cover of the detector remains closed, with any adjustments being carried out at the central measuring unit.

For an explosimeter, it is recommended that the detector should be calibrated by using the gas to be detected. If the user would like to calibrate the detector with a gas other than that detected and programmed in the factory, reference should be made to the table on page 30 by using the recommended gas and corresponding coefficient.

### 4.4.1 Zeroing

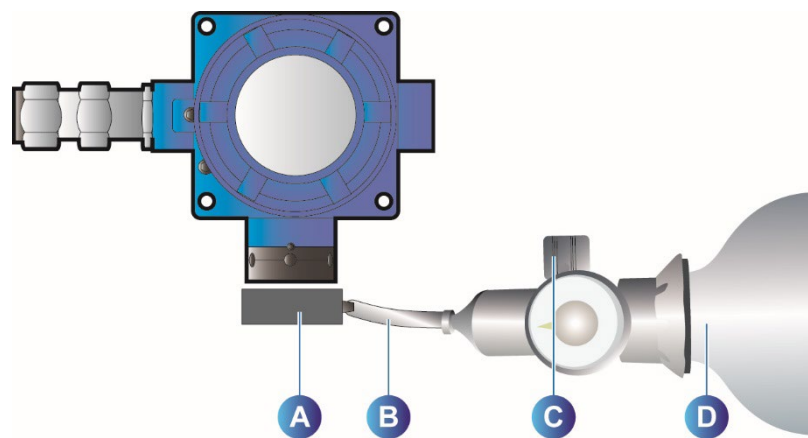

Figure 12 : Zeroing and Sensivity (OLC 100)

Proceed as follows :

1. Inhibit any alarm signals on the controller.
2. Place the calibration cup onto the detector head (Figure 12,"A").
3. Connect the calibrator cup to the pure air cylinder "D" using a flexible hose "B".
4. Open the valve on the zero air cylinder (flow rate 30 to 60 litres/h) "C".
5. After the measurement has stabilised (approx. 2 minutes), read the display of the central measuring unit.  
A displayed figure of "0.0" corresponds to 0% gas.
6. If a different value is displayed, adjust the "0" on the measuring unit to correct the value until a reading of exactly 0.0% is obtained.
7. Close the valve "C" on the cylinder. Remove the calibration cup "A" if no sensitivity control is necessary.
8. Reset any alarm signals on the controller.

## 4.4.2 Adjustment of gas sensitivity

This procedure takes place after the zeroing stage:

1. Inhibit any alarm signals on the controller.
2. Place the calibration cup onto the detector head (Figure 12, "A").
3. Connect the calibration cup to the calibration gas cylinder "D" by using a flexible hose "B".
4. Open the valve on the calibration gas cylinder "C" (flow rate 30 to 60 litres/hr).
5. After the measurement has stabilized (approx. 2 minutes), read the display of the central measuring unit.
6. Adjust "S" on the measuring unit in order to display the desired value.
7. Close valve "C" on the cylinder and remove the calibration cup "A".
8. Wait for the measured signal to return to zero and reset the alarm signals on the controller.

## 4.5 Calibrating the OLCT 100



Wait for the stabilization time on power-up.

For a LEL detector, it is recommended to calibrate with the targeted gas. Should the operator calibrate with another gas, please refer to tables on pages 28 to 30 to know the recommended calibration gas and the cross sensitivity factor.

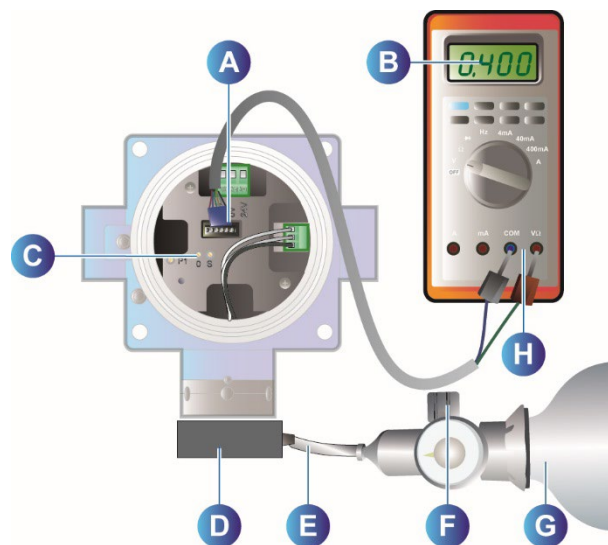

Figure 13: Zeroing and Sensitivity adjustment (OLCT 100)



## 4.5.1 Zeroing (OLCT 100)

Proceed as follows:

Inhibit any alarm signals on the controller.

2. Insert the blue and green plugs on the measurement lead into the + and - multimeter sockets, respectively (Figure 13, "H")
3. Insert the measurement lead plug into connector "A".
4. Place the calibration cup on the detector head ("D").
5. Connect the calibration cup to the pure air cylinder "G" by using a flexible hose "E".
6. Open the valve "F" on the pure air cylinder (flow rate 30 to 60 litres/h).
7. After the measurement has stabilized (approx. 2 minutes), read the value on the multimeter "B".

A measurement of 0.4 V corresponds to 4 mA, i.e. 0% gas.

Note: for the oxygen detector, inject pure nitrogen instead of air.

8. If a different value is displayed, adjust the "0" control ("C") in order to correct the value until 0.4 V is exactly displayed.
9. Close the valve "F" on the cylinder. Remove calibration ribbon cable "A", calibration pipe "D", and close the detector again if no sensitivity control is necessary.
10. Reset any alarm signals on the controller.

## 4.5.2 Sensitivity adjustment (OLCT 100)

This procedure enables the measurement to be adjusted corresponding to x% gas. Proceed as follows

1. Inhibit any alarm signals on the controller.
2. Insert the blue and green plugs on the measurement lead into the + and - multimeter sockets, respectively (Figure 13, "H").
3. Insert the measurement lead into connector "A".
4. Place the calibration cup on the detector head ("D").
5. Connect the calibration cup to the calibration gas cylinder "G" by using a flexible hose "E".  
A stainless steel pressure gauge and Teflon tube must be used for toxic gases and Freons.
6. Open the valve "F" on the calibration gas cylinder (flow rate 30 to 60 litres/h).
7. Once the measurement has stabilized (approx. 2 minutes), read the value on the multimeter.

Use the following formula to determine the voltage value that is to be displayed:

## OLC/OLCT100

GAS DETECTOR  
USER MANUAL

$$\text{Voltage displayed (mV)} = 400 + \frac{1600 \times \text{calibration gas concentration}}{\text{detector range}}$$

For example, for a range of 1000 ppm CO with a calibration gas cylinder of 300 ppm, the voltage displayed will be:

$$\text{Voltage displayed (mV)} = 400 + \frac{1600 \times 300}{1000} = 880 \text{ mV}$$

8. If a different value is displayed, adjust the "S" control ("C") to correct the value until an exact value of the calibration gas is displayed.
9. Close the valve "F" on the cylinder. Remove measurement cable "A", calibrate cup "D", and close the detector again.
10. Wait for the measured signal to return to zero and reset the alarm signals on the controller.

## Calibration coefficients of explosive gases for catalytic detectors

When a VQ1 type sensor is used (available for OLC 100 and OLCT 100), the coefficients are as follows:

Gas	Chemical Formula	LEL (%)	LSE (%)	Flash point (°C)	Vapor density	Coefficient-Calibration gas CH4 (methane)	Coefficient-Calibration gas H2 (Hydrogen)	Coefficient - Calibration gas C4H10 (Butane)	Coefficient - Calibration gas C5H12 (Pentane)	Coefficient - Calibration gas C3H8 (propane)
Ethyl acetate	C4H8O2	2.10	11.50	-4	3.0	1.65		0.90	0.80	
Acetone	C3H6O	2.15	13.00	-18	2.1	1.65		0.90	0.80	
Acetylene	C2H2	2.30	100	-18	0.9	2.35	1.90	1.25	1.15	
Acrylic acid	C3H4O2	2.40	8.00	54	2.5	5.00		2.65	2.40	
Butyl acrylate	C7H12O2	1.20	8.00	37	4.4	3.50		1.85	1.70	
Ethyl acrylate	C5H8O2	1.70	13.00	-2	3.5	3.05		1.65	1.50	
Acrylonitrile	C3H3N	2.80	28.00	-1	1.8	1.45	1.20	0.80	0.70	
Ammoniac	NH3	15.00	30.20	<-100	0.6	0.90	0.75	0.50	0.45	
Benzene	C6H6	1.20	8.00	-11	2.7	4.00		2.15	1.90	
1,3-Butadiene	C4H6	1.40	16.30	-85	1.9	2.55		1.35	1.25	
Butane	C4H10	1.50	8.50	-60	2.0	1.90		1.00	0.90	1.23
Butanol (Butyl Alcohol)	C4H10O	1.4	11.3	29	2.6	1.95		1.05	0.95	
2 - Butanone (MEK)	C4H8O	1.80	11.50	-4	2.5	3.90		2.10	1.90	
Cyclohexane	C6H12	1.20	8.30	-17	2.9	2.00		1.10	1.00	
Dimethylether	C2H6O	3.00	27.00	-41	1.6	1.80		0.95	0.90	
Dodecane	C12H26	0.60	~6.0	74	5.9	4.00		2.15	1.90	
Ethane	C2H6	3.00	15.50	135	1.0	1.50		0.80	0.75	
Ethanol	C2H6O	3.30	19.00	13	1.6	2.15	1.75	1.15	1.05	1.39
Ether (Diethylether)	(C2H5)2O	1.70	36.00	-45	2.6	1.90		1.00	0.90	
Ethylene	C2H4	2.70	34.00	-135	1.0	1.65	1.35	0.90	0.80	
LPG	Prop+But	1.65	~9.0	<-50	1.9	1.90		1.00	0.90	
Diesel	Melange	0.60	~6.0	55	>4	3.20		1.70	1.55	
Natural Gas	CH4	5.00	15.00	-188	0.6	1.05				
HFO-1234yf		6.2	12.3			1.35		0.75		
Heptane	C7H16	1.10	6.70	-4	3.5	2.20		1.20	1.05	
Hexane	C6H14	1.20	7.40	-23	3.0	2.10		1.15	1.00	
Hydrogen	H2	4.00	75.60	-	0.069	1.25	1.00			0.81
Isobutane	C4H10	1.50	8.40	-83	2.0	1.50		0.80	0.75	
Isobutene	C4H8	1.60	10.00	<-10	1.9	2.20		1.20	1.05	

# OLC/OLCT100

## GAS DETECTOR USER MANUAL

Gas	Chemical Formula	LEL (%)	LSE (%)	Flash point (°C)	Vapor density	Coefficient-Calibration gas CH4 (methane)	Coefficient-Calibration gas H2 (Hydrogen)	Coefficient - Calibration gas C4H10 (Butane)	Coefficient - Calibration gas C5H12 (Pentane)	Coefficient - Calibration gas C3H8 (propane)
Isopropanol	C3H8O	2.15	13.50	11.7	2.1	1.60		0.85	0.80	
Kerosene (JP4)	C10 - C16	0.70	5.00	> 50	> 4	5.00		2.65	2.40	
Methyl Methacrylate	C5H8O2	2.10	12.50	2	3.5	2.25		1.20	1.10	
Methane	CH4	5.00	15.00	-188	0.55	1.00				0.65
Methanol	CH3OH	5.50	44.00	11	1.1	1.40	1.15	0.75	0.70	
Naphtha	melange (Mixture)	0.90	5.90	> 44	> 4	3.50		1.85	1.70	
Nonane	C9H20	0.70	5.60	31	4.4	4.40		2.35	2.10	
Octane	C8H18	1.00	6.00	12	3.9	2.70		1.45	1.30	
Ethylene Oxyde	C2H4O	2.60	100	-20	1.5	2.10	1.70	1.15	1.00	
Propylene oxide	C3H6O	1.90	37.00	70	2.0	2.35	1.90	1.25	1.15	
Pentane	C5H12	1.40	8.00	-49	2.5	2.10		1.15	1.00	
Propane	C3H8	2.00	9.5	-104	1.6	1.55		0.85	0.75	1.00
Propylene	C3H6	2.00	11.70	-107.8	1.5	1.65		0.90	0.80	
Styrene	C8H8	1.1	8.00	31	3.6	6.30		3.35	3.00	
Gasoline lead free	/	1.10	~6.0	21	3 ÷ 4	1.80		0.95	0.90	
Toluene	C7H8	1.20	7	5	3.1	4.00		2.15	1.90	
Turpentine Oil	-	0.8	6.0	35	4.7	3.50		1.85	1.70	
Triethyl amine	C6H15N	1.20	8	-15	3.5	2.05		1.10	1.00	
White Spirit	melange (Mixture)	1.10	6.50	>30	> 4	3.50		1.85	1.70	
Xylene	C8H10	1.00	7.60	25	3.7	4.00		2.15	1.90	

Cells with a grey background: gases recommended for calibrating the detector

LEL and LSE value according to ISO 10156

**Table 2 : Calibration coefficients of explosive gases for catalytic detectors (VQ1)**

When an poison resistant 4F type sensor is used (only available for OLCT 100), the coefficients are as follows:

Gas	Chemical Formula	LEL (%Vol.)	LSE (%Vol.)	Vapor density	Coefficient- Calibration gas CH4 (methane)	Coefficient - Calibration gas C5H12 (Pentane)	Coefficient- Calibration gas H2 (Hydrogen)
Acetone	C <sub>3</sub> H <sub>6</sub> O	2.15	13.0	2.1	2.24	1.03	
Acetylene	C <sub>2</sub> H <sub>2</sub>	2.3	100	0.9	1.91		
Ammoniac	NH <sub>3</sub>	15.0	30.2	0.6	0.79	0.36	
Benzene	C <sub>6</sub> H <sub>6</sub>	1.2	8.0	2.7	2.45	1.13	
n-Butane	C <sub>4</sub> H <sub>10</sub>	1.5	8.5	2.0	2.16	0.99	
Ethane	C <sub>2</sub> H <sub>6</sub>	3.0	15.5	1.0	1.47	0.78	
Ethanol	C <sub>2</sub> H <sub>6</sub> O	3.3	19.0	1.6	1.37	0.63	
Ethylene	C <sub>2</sub> H <sub>4</sub>	2.7	34.0	1.0	1.41	0.65	
n-Hexane	C <sub>6</sub> H <sub>14</sub>	1.2	7.4	3.0	2.85	1.14	
Hydrogen	H <sub>2</sub>	4.0	75.6	0.07			1.0
Isopropanol	C <sub>3</sub> H <sub>8</sub> O	2.15	13.5	2.1	1.84	0.85	
JP-4					3.28	1.51	
JP-5					3.33	1.53	
JP-8					3.48	1.6	
Methane	CH <sub>4</sub>	5.0	15.0	0.55	1.0		
Methanol	CH <sub>3</sub> OH	5.5	44.0	1.1	1.27	0.58	
n-Pentane	C <sub>5</sub> H <sub>12</sub>	1.4	8.0	2.5	2.17	1.0	
Propane	C <sub>3</sub> H <sub>8</sub>	2.0	9.5	1.6	1.9	0.87	
Styrene	C <sub>8</sub> H <sub>8</sub>	1.1	8.0	3.6	2.13	0.98	
Toluene	C <sub>7</sub> H <sub>8</sub>	1.2	7.0	3.1	2.26	1.04	
Xylene	C <sub>8</sub> H <sub>10</sub>	1.0	7.6	3.7	2.8	1.29	

Cells with a grey background: gases recommended for calibrating the detector

LEL and LSE value according to ISO 10156

**Table 3 : Calibration coefficients of explosive gases for catalytic detectors with a 4F sensor.**

**Example**

Calibration of an "acetone" detector (VQ1) with a calibration gas of 1% volume butane

Value to be displayed:  $\frac{1\% \text{ (injected butane)}}{1.5\% \text{ (LEL butane)}} \times 100 \times 0.90 \text{ (butane/acetone coefficient)} = 60 \%$  LEL

Note:

- LEL values vary according to ISO10156 or IEC 80079-20-1 standards .
- Coefficients are accurate to ± 15%.

# OLC/OLCT100

GAS DETECTOR  
USER MANUAL



## 5 Preventive maintenance

*Periodic checks enable the equipment and installation to remain in conformity and ensure reliable detection. This chapter describes what preventative action should be taken and at what intervals. Inspection and maintenance are carried out in accordance with standards in force EN60079-17 or IEC 60079-17, EN 60079-29-2, EN 62990-2 with whatever editions are in force or with other national standards.*

### 5.1 Frequency of maintenance

Gas detectors are safety devices. TELEDYNE OLDHAM SIMTRONICS recommends the regular testing of fixed gas detection installations. This type of test consists of injecting the calibration gas into the detector at a sufficient concentration to activate the pre-set alarms. It is to be understood that this test is in no way a replacement for a detector calibration.

The frequency of gas tests depends on the industrial application where the detector is in use. Frequent inspections should be made in the months following the commissioning of the installation, and should then become more widely spaced provided that no significant deviation is observed. If a detector should fail to react in contact with the gas, calibration is essential. The frequency of calibrations shall be appropriate according to the results of the tests (humidity, temperature, dust, etc.); however, it must not exceed one year.

The general manager should put safety procedures in place on-site. TELEDYNE OLDHAM SIMTRONICS cannot be held responsible for their enforcement.



**To attain SIL capability level 1 in accordance with European standard EN 50402, Requirements relating to the safety operation of fixed gas detection systems, the maintenance interval for explosive gas detectors must be no more than 6 months. To obtain SIL capability level 2, the maintenance interval must be no more than 3 months**

---

## 5.2 Actions

Periodic maintenance comprises the following actions:

- Removal of dust from the sensor's protective housing, using only a dry cloth. No water or solvents should be used. Severely dusty heads or sensors should be replaced immediately.
- For use in dusty explosive atmospheres, the user should undertake full and regular cleaning to avoid the build-up of dust. The maximum permissible thickness of a dust layer must be less than 5 millimeters.
- Replacement of screws: if the screws on the fire-proof part "d" of the body need to be replaced, screws of equal quality A4 should be used.
- Zero inspection with pure air.

Gas sensitivity inspection and possible adjustment, as per chapter 4



## 6 Maintenance

*Maintenance primarily comprises changing any sensors that no longer meet their initial metrological characteristics.*



Since they are liable to affect detection reliability, the tasks described in this chapter are reserved for authorized trained personnel only.

Inspection and maintenance shall be carried out in accordance with standards EN60079-17 or IEC 60079-17, EN 60079-29-2, EN 62990-2 with whatever editions are in force or with other national standards.

The 4 mA level is factory-set. This value cannot be changed or adjusted. This check does not concern explosimeter OLC 100.

---

### 6.1 Opening the cover

This stage is necessary for the 4 mA check, zeroing, and calibration of the detector. Unscrew the lid of the enclosure by using a tool positioned like a cross.



All the necessary steps should be taken before opening the lid of the enclosure if it is installed in an ATEX zone, in particular:

- A fire permit from the appropriate department.
- Continuous use of a portable explosimeter.
- Use of an intrinsically safe multimeter.
- Reduction to an absolute minimum of the time involved.

This observation does not concern intrinsically safe versions that are used in an ATEX gas zone (see Specific instructions for use in explosive atmospheres and operational safety).

---

## 6.2 Checking the current generator

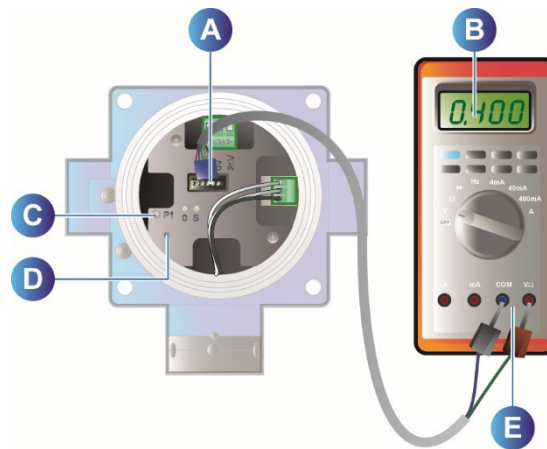

Figure 14: checking the current generator

Although this setting is made in the factory, it is possible that the transmitter and controller may have to be matched. In this case, proceed as follows

1. Insert the blue and green plugs on the measurement lead into the + and – multimeter sockets, respectively.
2. Insert the measurement lead plug into connector "A".
3. Use a small screwdriver to press the 4 mA adjust button "D".

The instrument then sends a 4 mA signal down the line. The multimeter displays 400 mV.

4. On the controller (measurement and automation), check that the measurement displayed corresponds to 0% of the measurement scale.
5. If some different value is displayed, keep pressing the button and adjust P1 ("C").
6. Release the push-button "D". Remove the measurement lead when adjustment is complete.

## 6.3 Possible errors

The table below summarizes the various possible detector errors:

### OLC 100 explosimeter

Observed fault	Possible cause	Action
Zero setting not possible	Sensor	Replace the sensor
	Cable	Check cable
	Main unit detector module	Check module
Sensitivity adjustment not possible	Sensor	Replace the sensor
	Connector cable	Check cable
	Inappropriate calibration gas	Check calibration gas concentration
High gas concentration indication	Maladjustment	Zero and span the detector

### OLCT 100 Detector

Observed fault	Possible cause	Action
Line current 0 mA	Connector cable	Check cable
	Power supply	Check voltage
	PCB	Replace the PCB
Line current < 1mA		Power the detector down then power it up (Off/On)
	Sensor	Replace the sensor
	PCB	Replace the PCB
	Line resistance too high	Check cable
	Power supply	Check voltage
Analog output is frozen at 20 mA	Gas concentration has reached 100% LEL	Proceed a power cycle (Off/On) Zero and span the detector
Courant de ligne >23mA	Over Range	Adjust zero and sensitivity settings Replace the sensor
Zero setting not possible	Sensor	Replace the sensor
	PCB	Replace the PCB
Sensitivity adjustment not possible	Sensor	Replace the sensor
	PCB	Replace the PCB
High gas concentration indication	Maladjustment	Adjust zero and sensitivity settings

## 6.4 Replacing sensor block

### 6.4.1 Standard Version



First follow the instructions in the section *Opening the cover*

The sensor block encloses the actual detector sensor itself. A sensor block can only be associated with a defined detector. A guide pin ensures that the sensor block goes together correctly

Figure 15: The sensor block (the black component)



(a) Blocking screw

Follow the procedure below :

- Inhibit any alarm signals on the controller.
- Switch off the supply to the detector.
- For a catalytic sensor, first remove the PCB connector.
- Loosen the locking screw (a) on the detector head and unscrew the head.
- Withdraw the (catalytic) detector head or the defective sensor block (OLCT 100).
- Replace the worn-out sensor with an identical part.
- Screw the detector head back on again and tighten the locking screws.
- Re-establish the supply to the detector from the controller.
- Adjust the settings for the new detector (see chapter 4 p 20).
- Close the detector cover.
- Reset any alarm signals on the controller.

### 6.4.2 High temperature version

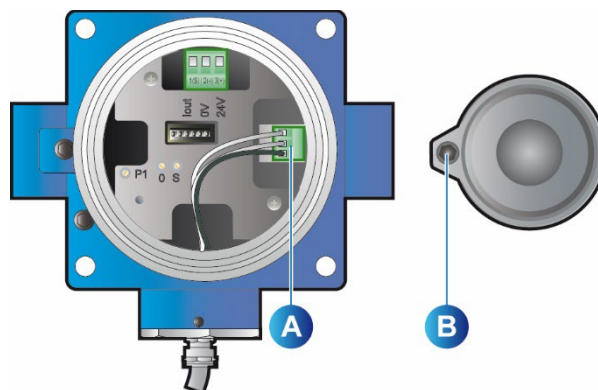

Figure 16 : OLCT 100 HT – elements specific to changing the high temperature sensor

Proceed as follows for the high temperature version.







- Inhibit any alarm signals on the controller.
- Switch off the supply to the detector.
- Loosen the maintenance screw (, "B") on the detector head cover and remove it.
- Replace the defective detector head and replace the maintenance screw "B" on the detector head cover. Disconnect the high temperature cable from terminal block "A" on the detector head. Connect the high temperature cable to terminal block "A".
- Screw the detector head back on again and tighten the locking screws.
- Re-establish the supply to the detector from the controller.
- Adjust the settings for the new detector (see chapter 4 p 20)
- Close the detector cover.
- Reset any alarm signals on the controller.







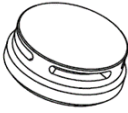

# OLC/OLCT100

GAS DETECTOR  
USER MANUAL



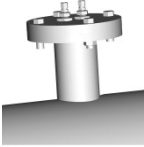

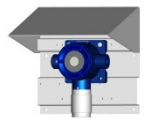
## 7 Accessories

Accessory	Utilization	Illustration	Reference
Tools kit	Tool kit for OLCT 100 including calibration cup, Allen key, sensor removal key and connector cable		6147879
humidifier kit	Used for the calibration of the semi-conductor transmitters		6335918
Calibration cup	Facilitates the injection of calibration gas on the sensor  Effect on measurement: measurement similar to that for natural diffusion  Effect on response time: none	 	6331141  Plastic material. Risk of electrostatic charges. Wipe with a damp cloth
PTFE remote sampling cup	Enables measurement in <i>bypass</i> mode  Effect on measurement: no effect if calibration is carried out under the same conditions (cup, flow rate)  Effect on response time: none		6327910  Plastic material. Risk of electrostatic charges. Wipe with a damp cloth
Splash-guard kit	Protects the detector against splashes  Effect on measurement: no effect.  Effect on response time: response time for natural diffusion can increase for certain gases. Contact us for details.		6329004  Plastic material. Risk of electrostatic charges. Wipe with a damp cloth
Stainless steel Splash-guard kit	Protects the detector against splashes  Effect on measurement: no effect.  Effect on response time: response time for natural diffusion can increase for certain gases. Contact us for details.		6129010

Accessory	Utilization	Illustration	Reference
Remote calibration cup	<p>Enables the detection of ambient gases simultaneously with a calibration gas injection pipe.</p> <p>Effect on measurement: no effect.</p> <p>Effect on response time: negligible.</p>	 	<p>6327911</p> <p>Plastic material. Risk of electrostatic charges. Wipe with a damp cloth</p>
PTFE water barrier	<p>Protects the gas inlet from dust and splashing</p> <p>Effect on measurement: no effect, but cannot be used for detecting O<sub>3</sub>, HCl, HF, or Cl<sub>2</sub>.</p> <p>Effect on response time: response time increased (contact us for heavy gases of a density greater than 3 and at low concentrations &lt; 10 ppm)</p>	 	<p>6335975</p> <p>Plastic material. Risk of electrostatic charges. Wipe with a damp cloth</p>
Universal Pitot tube	<p>Enables the measurement of a gas passing through a sheath</p> <p>Requires the use of the gas circulation head</p> <p>Effect on measurement: no effect.</p> <p>Effect on response time: negligible.</p>		<p>6793322</p>
Mounting kit	<p>Enables a detector to be fixed to the ceiling.</p> <p>Effect on measurement: no effect.</p> <p>Effect on response time: no effect.</p>		<p>6322420</p>
Sunshield	<p>Protects any detector mounted on the outside of a building.</p> <p>Effect on measurement: no effect.</p> <p>Effect on response time: negligible.</p>		<p>6123716</p>
Wall mounting gas collector	<p>Allows the sensor to detect more quickly the gas. (Wall mounting)</p> <p>Effect on measurement: no effect.</p> <p>Effect on response time: response time can increase up to 10%.</p>		<p>6331169</p>



Accessory	Utilization	Illustration	Reference
Ceiling gas collector	<p>Allows the sensor to detect more quickly the gas. (Ceiling)</p> <p>Effect on measurement: no effect.</p> <p>Effect on response time: response time can increase up to 10%.</p>		6331168
Replacement adaptater kit	<p>Enables replacement of an existing detector without having to re-drill holes.</p>		6793718
Duct Mounting kit			B301372

## 7.1 Cable gland

Purpose	Reference
M20 cable gland for non-armoured cable Material: stainless steel	6343493
M20 cable gland for non-armoured cable Material: Nickel-plated brass (not recommended for use with ammonia or acetylene)	6343499
M20 cable gland for armoured cable Material: stainless steel	6343489
M20 cable gland for armoured cable. Material: Nickel-plated brass (not recommended for use with ammonia or acetylene)	6343495

## 8 Spare parts

*List of spares for the various detectors*

Part Number	Description
6314010	Catalytic sensor 0-100% LEL VQ1 for OLC 100 and OLCT 100 (Standard version only)
6313994	Catalytic sensor 0-100% LEL 4F for OLCT 100 (poison resistant version only. Not compatible with standard version)
6314296	MEMS sensor 0-100% LEL for OLCT100 (IEC %LEL)
6314295	MEMS sensor 0-100% LEL for OLCT100 (ISO %LEL)
6314292	Infra-red sensor 0-5% vol. CH <sub>4</sub> for OLCT 100 XPIR
6314293	Infrared sensor 0-4.4% vol. CH <sub>4</sub> for OLCT 100 XPIR
6314220	Infrared sensor 0-100% LEL R1234yf for OLCT 100 XPIR
6314221	Infra-red sensor 0-2000 ppm R1234yf for OLCT 100 XPIR
6314222	Infrared sensor 0-2000 ppm R134a for OLCT 100 XPIR
6314223	Infrared sensor 0-2000 ppm R407f for OLCT 100 XPIR
6314224	Infrared sensor 0-2000 ppm SF <sub>6</sub> for OLCT 100 XPIR
6314259	Infrared sensor 0-2000 ppm R32 for OLCT 100 XPIR
6314260	Infrared sensor 0-2000 ppm R1234ze for OLCT 100 XPIR
6314261	Infrared sensor 0-5000 ppm R1233zd for OLCT 100 XPIR
6314142	Infrared sensor 0-5000 ppm CO <sub>2</sub> for OLCT 100 XPIR
6314043	Infra-red sensor 0-5% vol. CO <sub>2</sub> for OLCT 100 XPIR
6314109	Infrared sensor 0-10% vol. CO <sub>2</sub> for OLCT 100 XPIR
6314145	Infrared sensor 0-100% vol. CO <sub>2</sub> for OLCT 100 XPIR
6314016	Electrochemical sensor 0-30% O <sub>2</sub> for OLCT 100 XP (life expectancy 2 years)
6351237	Electrochemical sensor 0-30% O <sub>2</sub> for OLCT 100 IS (life expectancy 2 years)
6314C5A	Electrochemical sensor 0-30% O <sub>2</sub> for OLCT 100 (life expectancy 5 years)
6314017	Electrochemical sensor 0-100 ppm, 0-300 ppm and 0-1000 ppm CO for OLCT 100
6314018	Electrochemical sensor 0-30.0 ppm, 0-100 ppm H <sub>2</sub> S for OLCT 100
6314019	Electrochemical sensor 0-1000 ppm H <sub>2</sub> S for OLCT 100

Part Number	Description
6314125	Electrochemical sensor 0-5000 ppm H <sub>2</sub> S for OLCT 100
6314020	Electrochemical sensor 0-100 ppm, 0-300 ppm and 0-1000 ppm NO for OLCT 100
6314021	Electrochemical sensor 0-10.0 ppm and 0-30.0 ppm NO <sub>2</sub> for OLCT 100
6314022	Electrochemical sensor 0-10.0 ppm, 0-30.0 ppm and 0-100 ppm SO <sub>2</sub> for OLCT 100
6314025	Electrochemical sensor 0-10.0 ppm Cl <sub>2</sub> for OLCT 100
6314023	Electrochemical sensor 0-2000 ppm H <sub>2</sub> for OLCT 100
6314188	Electrochemical sensor 0-4% Vol. H <sub>2</sub> for OLCT 100
6314026	Electrochemical sensor 0-30.0 ppm, 0-100 ppm HCl for OLCT 100
6314028	Electrochemical sensor 0-10.0 ppm and 0-30.0 ppm HCN for OLCT 100
6314029	Electrochemical sensor 0-100 ppm NH <sub>3</sub> for OLCT 100
6 314 211	Electrochemical sensor 0-100 ppm NH <sub>3</sub> for OLCT 100 (low temperature -40°C)
6314030	Electrochemical sensor 0-300 and 0-1000 ppm NH <sub>3</sub> for OLCT 100
6314031	Electrochemical sensor 0-5000 ppm NH <sub>3</sub> for OLCT 100
6314033	Electrochemical sensor 0-1.00 ppm PH <sub>3</sub> for OLCT 100
6314035	Electrochemical sensor 0-3.00 ppm ClO <sub>2</sub> for OLCT 100
6314024	Electrochemical sensor 0-30.0 ppm, 0-100 ppm ETO for OLCT 100 Electrochemical sensor 0-50.0 ppm, 0-100 ppm CH <sub>2</sub> O for OLCT 100
6314032	Electrochemical sensor 0-1.00 ppm AsH <sub>3</sub> for OLCT 100
6314027	Electrochemical sensor 0-50.0 ppm SiH <sub>4</sub> for OLCT 100
6314271	Electrochemical sensor 0-1.00 ppm COCl <sub>2</sub> for OLCT 100
6314148	Electrochemical sensor 0-100 ppm C <sub>2</sub> H <sub>6</sub> S for OLCT 100
6314178	Electrochemical sensor 0-100 ppm CH <sub>4</sub> S for OLCT 100
6314036	Semiconductor sensor for methyl and methylene chloride for OLCT 100
6314037	Semiconductor sensor for R12, R22, R123 and FX56 freons for OLCT 100
6314038	Semiconductor sensor for R134a, R11, R23, R143a, R404a, R507, R410a, R32, R407c and R408a freons for OLCT 100
6314039	Semiconductor sensor for ethanol, toluene, isopropanol, 2-butanone and xylene for OLCT 100
6451626	OLC 100 Board

Part Number	Description
6451646	OLCT 100 IR Board (CO <sub>2</sub> )
6451700	OLCT 100 IR Board (CH <sub>4</sub> , R1234yf, R134a, R407f and SF <sub>6</sub> ) OLCT 100 XP Board for MEMS sensor
6451621	OLCT 100 SC Board
6451594	OLCT 100 XP 0-100% LEL Board (standard version)
6451696	OLCT 100 XP 0-100% LEL Board (Poison resistant version)
6451623	OLCT 100 toxic Board IS or NO version
6451649	Usual EC OLCT 100 XP Board (CO, H <sub>2</sub> S, H <sub>2</sub> , NH <sub>3</sub> , DMS, Ethylmercaptan)
6451648	OLCT 100 O <sub>2</sub> Board (for OLCT 100 XP with 6314016 only)
6451681	OLCT 100 O <sub>2</sub> Board (for OLCT 100 XP with 6314C5A only)

# OLC/OLCT100

GAS DETECTOR  
USER MANUAL

## 9 Technical specifications

### 9.1 Dimensional characteristics

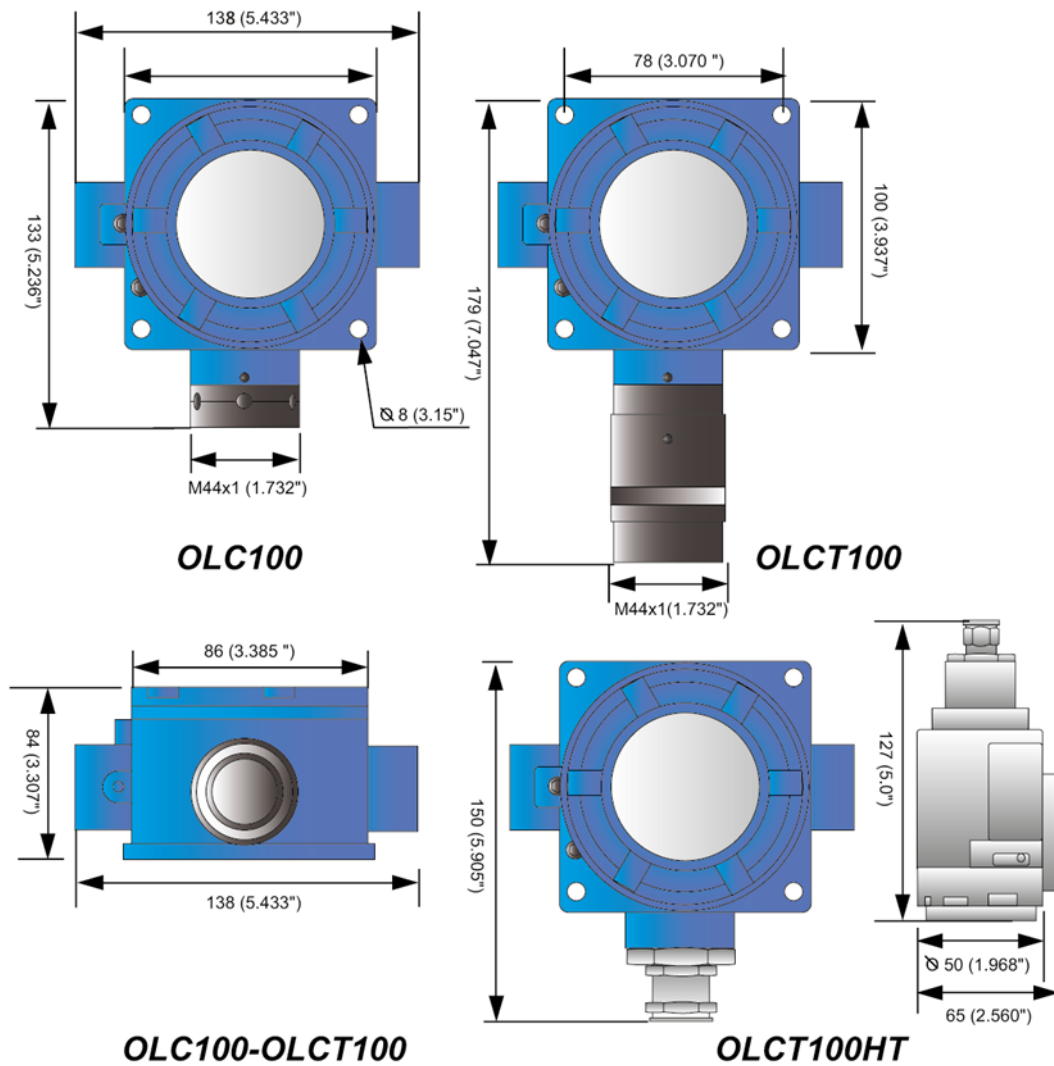

Figure 17: dimensional characteristics of the detectors

## 9.2 General Specifications

---

Supply voltage at the detector terminals (Vdc) :	<ul style="list-style-type: none"><li>• OLC 100 : 340 mA (only by Oldham Controller)</li><li>• OLCT 100 XP HT : 15.5 V to 32 V</li><li>• OLCT 100 XP CAT : 15.5 V to 32 V</li><li>• OLCT 100 XP IR : 13.5 V to 32 V</li><li>• OLCT 100 XP MEMS : 13.5 V to 32 V</li><li>• OLCT 100 XP EC : 11 V to 32 V</li><li>• OLCT 100 IS EC : 11 V to 32 V</li><li>• OLCT 100 XP SC : 15.5 V to 32 V</li></ul>
Average consumption :	<ul style="list-style-type: none"><li>• OLC 100 : 340 mA</li><li>• OLCT 100 XP HT : 100 mA</li><li>• OLCT 100 XP CAT : 110 mA</li><li>• OLCT 100 XP IR : 80 mA</li><li>• OLCT 100 XP MEMS : 30 mA</li><li>• OLCT 100 XP EC : 23.5 mA</li><li>• OLCT 100 IS EC : 23.5 mA</li><li>• OLCT 100 XP SC : 100 mA</li></ul>
Output current (signal) :	<ul style="list-style-type: none"><li>• Current source encoded from 0 to 23 mA (non isolated)</li><li>• Linear 4 to 20 mA current reserved for measurement</li><li>• 0 mA: electronic fault or no power supply</li><li>• &lt; 1 mA: fault</li><li>• 2 mA : initialization mode</li><li>• frozen to 20 mA : the concentration of combustible gas has reached 100% LEL</li></ul>
Type of cable :	<ul style="list-style-type: none"><li>• Explosimeter : screened, 3 active wires</li><li>• HT Explosimeter : screened, 3 active wires</li><li>• Electrochemical OLCT 100 XP : screened, 2 active wires</li><li>• Electrochemical OLCT 100 IS : screened, 2 active wires (IS cable)</li><li>• Infra-red detector : screened, 3 active wires</li><li>• MEMS detector : screened, 3 active wires</li><li>• Semiconductor detector : screened, 3 active wires</li></ul>

---



---

Cable inlet : M20x1.5 (cable gland not supplied) or ¾ NPT

---

Maximum diameter of cable 12 mm  
entering the detector :

---

Electromagnetic Conforms to EN50270:06 (typ2)  
compatibility :

---

Ingress Protection : IP66

---

# OLC/OLCT100

GAS DETECTOR  
USER MANUAL

---

Approvals :

Compliant to European Directive ATEX 2014/34/UE and to IEC Ex schedule for fire-proof detectors

SIL 2 in accordance with EN50402:05 / EN61508:11 \*

Performance approved according to EN 60079-29-1:16 (VQ1 catalytic bead)

Performance approved according to EN 50104:10 (oxygen detectors)

---

Weight :

- OLC 100 : 0.950 kg
- OLCT 100 XP HT : 1.8 kg
- OLCT 100 XP CAT : 1.0 kg
- OLCT 100 XP IR : 1.1 kg
- OLCT 100 XP EC : 1.1 kg
- OLCT 100 IS EC : 1.1 kg
- OLCT 100 XP SC : 1.1 kg

---

Materials: Epoxy painted aluminum. 316 Stainless Steel in option

---

\*Gas depending

## 9.3 Catalytic sensor (OLCT 100 XP)

Measurement range :	0 – 100% LEL
Measurement principle :	catalytic
Accuracy :	see table below
Temperature range :	see table below
Relative humidity :	0 to 95% RH (non-condensing relative humidity)
Pressure :	atmospheric $\pm$ 10%
Response time :	T <sub>50</sub> = 6 seconds. T <sub>90</sub> = 15 seconds for Methane
Lifetime (typical) :	48 months
Storage conditions :	-40 to 70°C, 20 to 60% RH, 1 bar $\pm$ 10%, 6 months maximum
Warm-up time (max) :	2 hours to first switching on power

### Specific characteristics

Type of sensors	Accuracy	Operating temperature range
Anti-poison sensor 4F (unmarked sensor)	1% LEL between 0- 70 %LEL 2% of the measurement between 71 and 100% LEL	-40 to +70°C
VQ1 sensor (sensor with identifying mark)	1% LEL between 0-70%LEL OLCT 100 : 2% of the measurement between 71 and 100% LEL OLC 100 : 5% of the measurement between 71 and 100 % LEL	-40 to +70°C
VQ1 sensor, high temperature assembly	1% LEL between 0-70%LEL 2% of the measurement between 71 and 100% LEL	-20 to +200°C



Mark on sensor VQ1



4F poison resistant sensor

**Figure 18: mark on VQ1 sensor**

## 9.4 Toxic sensors (OLCT 100 XP and OLCT 100 IS)

### Common characteristics

Measurement principle : Electrochemical sensor

Pressure : Atmospheric  $\pm 10\%$

Type of gas		Measurement range (ppm)	XP Version	IS Version	Temperature range °C	% RH (at 20°C)	Accuracy (ppm)	Lyfe (months)	Reponse time T <sub>50</sub> / T <sub>90</sub> (s)	Storage condition s	Warm-up time max (h)
AsH <sub>3</sub>	Arsine	1.00		•	-20 to +40	20 - 90	+/- 0.05	18	30/120	(1)	1
CH <sub>2</sub> O	Formaldehyde	50.0		•	-20 to +50	15 - 90	+/- 1.5	36	50/240	(1)	36
Cl <sub>2</sub>	Chlorine	10.0		•	-20 to +40	10 - 90	+/- 0.4	24	10/60	(1)	1
ClO <sub>2</sub>	Chlorine Dioxide	3.00		•	-20 to +40	10 - 90	+/- 0.3	24	20/120	(1)	1
CO	Carbon monoxide	100	•	•	-20 to +50	15 - 90	+/- 3 (range 0-100)	36	15/40	(1)	1
		300	•	•							
		1,000	•	•							
COCl <sub>2</sub>	Phosgene	1,00		•	-20 to +40	15 - 90	+/- 0.05	12	60/180	(2)	1
ETO	Ethylene Oxide	30.0		•	-20 to +50	15 - 90	+/- 1	36	50/240	(1)	36
H <sub>2</sub>	Hydrogen	2,000	•	•	-20 to +50	15 - 90	+/-5 %	24	30/50	(1)	1
H <sub>2</sub> S	Hydrogen Sulfide	30.0	•	•	-40 to +50	15 - 90	+/- 1.5 (range 0-30)	36	15/30	(1)	1
		100	•	•							
		1,000	•	•							
HCl	Hydrogen Chloride	30.0		•	-20 to +40	15 - 95	+/- 0.4 (range 0-10)	24	30/150	(1)	24
		100		•							
NH <sub>3</sub>	Ammonia	100	•	•	-20 to +40	15 - 90	+/- 5	24	50/90	(1)	1
		1,000	•	•							
		5,000	•	•							
NH <sub>3</sub>	Ammonia	1,000	•	•	-40 to +40	15 - 90	+/- 20	24	--	(1)	1
		100	•	•							
		300	•	•							
NO	Nitric Oxide	300	•	•	-20 to +50	15 - 90	+/- 2 (range 100)	36	10/30	(1)	12
		1,000	•	•							
NO <sub>2</sub>	Nitrogen Dioxide	10.0		•	-20 to +50	15 - 90	+/- 0.8	24	30/60	(1)	1
		30.0		•							
O <sub>2</sub>	Oxygen (>2years)	0-30% vol	•	•	-20 to +50	15 - 90	+/- 0,5% vol. from 0 to +50°C -1,25% vol. max from -20°C to 0°C	30	6/15	(1)	1
O <sub>2</sub>	Oxygen (>5years)	0-30% vol	•		-40 to +50	+/- 2% of the measurement between 15% and 90%	+/- 2% of the measurement between -10 ° C and + 40 ° C <sup>(3)</sup>	60	15/25	(1)	1.5

Type of gas	Measurement range (ppm)	XP Version	IS Version	Temperature range °C	% RH (at 20°C)	Accuracy (ppm)	Lyfe (months)	Reponse time T <sub>50</sub> / T <sub>90</sub> (s)	Storage condition s	Warm-up time max (h)
PH <sub>3</sub>	Phosphine	1.00	•	-20 to +40	20 - 90	+/- 0.05	18	30/120	(1)	1
SiH <sub>4</sub>	Silane	50.0	•	-20 to +40	20 - 95	+/- 1	18	25/120	(1)	1
SO <sub>2</sub>	Sulfur Dioxide	10,0	•	-20 to +50	15 - 90	+/- 0.7 (range 0-10)	36	15/45	(1)	1
		30.0	•							
		100	•							

(1) 4 – 20 °C  
20 – 60 % RH  
1 bar ± 10 %  
6 months maximum

(2) 4 – 20 °C  
20 – 60 % RH  
1 bar ± 10 %  
3 months maximum

(3) +/-5% max of the measurement over the rest of the temperature range according to the metrological standard EN50104

## 9.5 Semiconductor sensors (OLCT 100 XP)

Measurement principle :	semiconductor
Temperature range :	-20°C to +55°C
Relative humidity :	20 to 95% RH (non-condensing relative humidity)
Pressure :	atmospheric $\pm$ 10%
Lifetime (typical) :	40 months
Storage conditions :	-20 to 50 °C, 20 to 60% RH, 1 bar $\pm$ 10%, 6 months maximum
Warm-up time (max) :	4 hours to first switching on power

Type of gas	Measurement range	Accuracy	T <sub>50</sub> / T <sub>90</sub> (s)	
Methyl chloride CH <sub>3</sub> Cl	500 ppm	+/- 15%	25/50	
Methylene chloride CH <sub>2</sub> Cl <sub>2</sub>	500 ppm	(from 20 to 70% FS)		
Freon R12	1 %vol		25 / 50	
Freon R22	2,000 ppm	+/- 15%		
Freon R123	2,000 ppm	(from 20 to 70% FS)		
FX56	2,000 ppm			
Freon R134A	2,000 ppm		25 / 50	
Freon R11	1 % vol			
Freon R23	1 % vol			
Freon R143A	2,000 ppm			
Freon R404A	2,000 ppm	+/- 15%		
Freon R507	2,000 ppm	(from 20 to 70% FS)		
Freon R410A	1,000 ppm			
Freon R32	1,000 ppm			
Freon R407C	1,000 ppm			
Freon 408A	4,000 ppm			
Ethanol	500 ppm			
Toluene	500 ppm			
Isopropanol	500 ppm			
2-butanone ( MEK)	500 ppm	+/- 15%		25 / 50
Xylene	500 ppm	(from 20 to 70% FS)		
R1234YF	1000ppm			
R1234ZE	1000ppm			

## 9.6 Infrared sensors (OLCT 100 XP-IR)

Measurement principle : - Infra-red absorption

Pressure : 1 bar ± 10%

Type of gas	Measureme nt range (ppm)	XP Version	Temperature range °C	% RH	Accuracy (ppm)	Lyfe (months )	Reponse time T <sub>50</sub> / T <sub>90</sub> (s)	Storage conditions	Warm- up time max (h)
CO <sub>2</sub> carbon dioxide	5,000	•	-25 to +50	15 - 90	+/- 150	60	15/30	(6)	2
	5 % Vol.	•			+/- 0.15%				
	10% Vol.	•			+/- 0.3%				
	100% Vol.	•			+/- 3%				
CH <sub>4</sub> Methane	4.4% Vol. 5.0% Vol.	•	-40 to +60	0 - 90	+/- 5%FS (from 50 to 100%LEL)	60	25/70	(5)	2
R1233ZD	5,000	•	-20 to +50	0 - 95	+/- 40 (from 0 to 50% FS) +/- 100 (from 50 to 100% FS)	60	40/170	(5)	2
R1234YF Tetrafluoro- propene	2,000	•	-20 to +50	0 - 95	+/- 40 (from 0 to 50% FS)	60	25/120	(5)	2
	0-100% LEL	•			+/- 100 (from 50 to 100% FS)		30/115		
		•			+/- 2% (from 0 to 50% LEL) +/- 5% (from 50 to 100% LEL)				
R1234ZE	2,000	•	-20 to +50	0 - 95	+/- 40 (from 0 to 50% FS) +/- 100 (from 50 to 100% FS)	60	40/170	(5)	2
R32	2,000	•	-20 to +50	0 - 95	+/- 40 (from 0 to 50% FS) +/- 100 (from 50 to 100% FS)	60	40/170	(5)	2
R134A Tetrafluoro- ethane	2,000	•	-20 to +50	0 - 95	+/- 40 (from 0 to 50% FS) +/- 100 (from 50 to 100% FS)	60	40/170	(5)	2
R407F	2,000	•	-20 to +50	0 - 95	+/- 40 (from 0 to 50% FS) +/- 100 (from 50 to 100% FS)	60	40/105	(5)	2
R449A	2,000	•	-20 to +50	0 - 95	+/- 40 (from 0 to 50% FS) +/- 100 (from 50 to 100% FS)	60	40/170	(5)	2
R452A	2,000	•	-20 to +50	0 - 95	+/- 40 (from 0 to 50% FS) +/- 100 (from 50 to 100% FS)	60	40/170	(5)	2
R454B	0-100% LEL	•	-20 to +50	0 - 95	+/- 2% (from 0 to 50% LEL)	60	30/115	(5)	2
SF <sub>6</sub> Sulfur hexafluoride	2,000	•	-20 to +50	0 - 95	+/- 40 (from 0 to 50% FS) +/- 100 (from 50 to 100% FS)	60	50/160	(5)	2

(5) -40 – 85 °C  
0 – 80 % RH  
6 months maximum

(6) 4 – 20 °C  
10 – 60 % RH  
6 months maximum

## 9.7 MEMS sensors (OLCT 100 XP)

Measurement range :	0-100% LEL
Measurement principle :	Thermal conductivity on MEMS sensor (Micro-Electro Mechanical Systems)
Pressure :	80 – 120 kPa atmospheric ± 20%
Temperature range :	-40 to +60°C
Accuracy :	H <sub>2</sub> : +/- 5 % LEL, CH <sub>4</sub> +/- 3 % LEL
Relative humidity :	0 to 95 % RH (non-condensing relative humidity)
Reponse time :	H <sub>2</sub> : T90 <20s, CH <sub>4</sub> : T90 <22s
Lifetime (typical) :	15 years
Storage conditions :	-40 to 70 °C, 20 to 60 %RH, 1 bar ± 10%, 6 months maximum
Warm-up time (max) :	2 hours to first switching on power

The accuracies shown in the table below are achieved without target gas-specific calibration. Accuracy levels are therefore much better than those obtained with a catalytic or infrared sensor.

Type de gas	LEL (%Vol.) (ISO 10156)	Accuracy at 50% LEL (ISO 10156)	LEL (%Vol.) (IEC80079-20-1)
C <sub>4</sub> H <sub>10</sub> Butane	1.8	±5 %LEL	1.4
C <sub>2</sub> H <sub>6</sub> Ethane	3.0	±5 %LEL	2.4
H <sub>2</sub> Hydrogène	4.0	±5 %LEL	4.0
HC(CH <sub>3</sub> ) <sub>3</sub> Isobutane	1.8	±5 %LEL	1.3
C <sub>4</sub> H <sub>8</sub> Isobutylene	1.8	±5 %LEL	1.8
C <sub>3</sub> H <sub>8</sub> O Isopropanol	2.0	±10 %LEL	2.0
CH <sub>4</sub> Méthane	5.0	±3 %LEL	4.4
C <sub>4</sub> H <sub>8</sub> O MEK	1.4	±5 %LEL	1.5
C <sub>5</sub> H <sub>12</sub> Pentane	1.5	±5 %LEL	1.1
C <sub>3</sub> H <sub>8</sub> Propane	2.1	±6 %LEL	1.7
C <sub>3</sub> H <sub>6</sub> Propylene	2.4	±5 %LEL	2.0
C <sub>3</sub> H <sub>6</sub> O Acétone	2.5	+20 %LEL	2.5
C <sub>2</sub> H <sub>4</sub> Ethylene	2.7	-12 %LEL	2.3
C <sub>7</sub> H <sub>16</sub> Heptane	1.1	±12 %LEL	0.85



Type de gas		LEL (%Vol.) (ISO 10156)	Accuracy at 50% LEL (ISO 10156)	LEL (%Vol.) (IEC80079-20-1)
$C_8H_{18}$	Octane	1.0	$\pm 12$ %LEL	0.8
$C_8H_8$	Styrène	1.1	-20 %LEL	1.0
$C_7H_8$	Toluène	1.2	$\pm 12$ %LEL	1.0
$C_8H_{10}$	Xylène	1.1	$\pm 12$ %LEL	1.0

# OLC/OLCT100

GAS DETECTOR  
USER MANUAL



# 10 Specific instructions for use in explosive atmospheres and operational safety

## 10.1 General comments

OLC/OLCT 100 conforms to the requirements of European Directive ATEX 2014/34/UE relating to explosive Dust and Gas atmospheres. On account of their metrological performance as tested by the accredited organization INERIS (in process), the OLC/OLCT 100 transmitter detectors intended for the measurement of explosive gases are classed as safety devices in the sense of the European Directive and may, therefore, contribute to limiting the risks of explosion.

The information given in the following sections should be respected and taken into account by the manager of the site where the equipment is installed. As far as the aim of improving the health and safety of workers who are exposed to the risks of explosive atmospheres is concerned, refer to European Directive ATEX 1999/92/CE.

OLC/OLCT 100 detectors also conform to the requirements of the IEC international certification scheme relating to explosive Dust and Gas atmospheres.

Two modes of protection can be used:

- The mode of protection using fire-proof housing "db" for gaseous explosive atmospheres, or housing "tb" for explosive dust atmospheres.
- The intrinsically safe "ia" mode of protection for gaseous explosive or dust atmospheres.

## 10.2 Cable Entries

Cable glands shall be flameproof certified ('d' or 'db') for use in explosive atmospheres. Ingress Protection will be greater or equal to IP66. Cable glands will be mounted according to IEC/EN 60079-14 standard, edition in force, and to additional requirements from local standards. They shall be of M20x1.5 or ¾ NPT type. In the case of an ISO thread (M20), the engagement shall be 5 threads at least. Cables used shall have an operating temperature range equal or greater than 80 °C.

## 10.3 Threaded joints

Explosion-proof seals have values different from those specified in the tables of standard EN 60079-1. TELEDYNE OLDHAM SIMTRONICS does not allow repairs and disclaims any responsibility for material modifications.

The threaded joints on the OLC(T) 100 may be lubricated to maintain fire-proof protection. Only non-hardening lubricants or non-corrosive agents having no volatile solvents may be used. Warning: silicone based lubricants are strictly forbidden, since they contaminate the OLC(T) 100 detector elements.

## 10.4 Electrostatic Hazard

Accessories in plastic material (see Chapter 7) may present a risk of static discharge. Do not rub with a dry cloth. Clean with water and wipe only with a damp cloth.

## 10.5 Metrological performance for the detection of flammable gases

Standard VQ1 OLC/OLCT 100 filament version detectors conform to IEC / EN 60079-29-1 standards, *Suitability requirements for the operation of flammable gas detectors*, category 0 to 100% LEL Group II, reference gas 0-100% LEL Methane and Propane.

These detectors are classed as safety devices according to ATEX 2014/34/UE Directive and may, therefore, contribute to limiting the risks of explosion. For this to be so, they must be connected to TELEDYNE OLDHAM SIMTRONICS type MX 15, MX 32, MX 42A, MX 48, MX 43, MX 52 or MX 62 detection controllers, or connected to measuring systems that are certified according to IEC / EN standards 60079-29-1 and compatible with their characteristics (see transfer curve).

### 10.5.1 Transfer curve

The curve shown gives the transmitter output current as a function of the gas concentration. If the user connects the transmitter to a controller other than the one provided by TELEDYNE OLDHAM SIMTRONICS, they should be certain that the transfer curve is fully compatible with the input characteristics of their equipment to ensure the proper interpretation of the information provided by the transmitter. Similarly, the controller should provide sufficient voltage to compensate for any voltage drop in the cable.

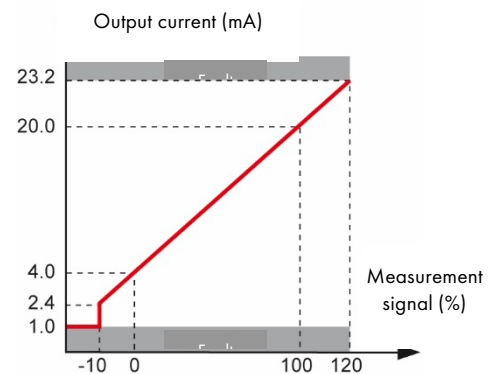

Figure 19: transfer curve for a 4-20 mA detector

## 10.6 Specific Conditions of Use

- On J2 connector, shall be used only for the connection of equipment certified for use in explosive atmospheres of group IIC or IIIC; this equipment must not take the form of a voltage generator or a current generator.
- The connection of the gas detector type OLCT100 IS to the associated equipment must be carried out in accordance with the electrical parameters indicated in this certificate, in accordance with the requirements of intrinsically safe circuits.
- The flameproof joints have different values from those specified in the tables of the EN 60079-1 standard, contact the manufacturer for any repair.
- The remote sensor of the OLCT 100 HT gas detector can be used in the following ranges of ambient temperatures:
  - from -20°C to 200°C with temperature class T2,
  - from -20°C to 180°C with temperature class T3,
  - from -20°C to 110°C with temperature class T4.

## 10.7 Specific Conditions of Use for FM

### 10.7.1 *OLCT 100* detectors

- The Detector *OLCT 100* complies with the relevant gas detection performance standard listed on the label when connected to a Gas Detection Control Panel that also has been evaluated to the same gas detection performance standard.
- The detector evaluation following the standard ANSI/FM 60079-29-1 has been done without any consideration of the IP Rating of the enclosure.

## 10.8 Specific Conditions of use for CSA

### 10.8.1 Warning for OLCT 100-XP Models

“WARNING – DO NOT OPEN WHEN ENERGIZED”

“WARNING – A SEAL SHALL BE INSTALLED WITHIN 50 mm (2”) OF THE ENCLOSURE”, for aluminum enclosure.

“WARNING – A SEAL SHALL BE INSTALLED WITHIN 450 mm (18”) OF THE ENCLOSURE”, for stainless steel enclosure.

### 10.8.2 Warning for OLCT 100-IS

“WARNING: Substitution of components may impair Intrinsic Safety”

### 10.8.3 Conditions of certifications

Wireless communication shall not be used for safety related functions and may only be used for data acquisition.

#### For OLCT-100-XP

1. Metric threaded conduit entries shall be equipped with suitably certified metric to NPT adaptors.
2. Wiring used for external connections shall be rated at least 20K higher than the maximum ambient temperature.
3. The equipment shall be supplied by Class 2 or limited energy source in accordance with CAN/CSA C22.2 No 61010-1 and ANSI/UL 61010-1
4. Measures must be taken to avoid ignition due to mechanical impact or friction for models housed in aluminum enclosure.
5. Conduit seal shall be installed within 50 mm (2") of the equipment housed in aluminum enclosure and within 450 mm (18") of the equipment housed in stainless steel enclosure.
6. The flameproof joints shall not be repaired
7. OLCT100XP is compliant to CSA performance (CSA 60079-29-1) only when connected to an OLDHAM performance compliant control unit.
8. Flammable gas detection performance are not assessed for dust environment and environmental conditions.
9. Firmware version associated with combustible gas detection according to requirements of 60079-29-1 is V.013.

#### For OLCT-100-IS

1. Measures must be taken to avoid ignition due to mechanical impact or friction for models housed in aluminum enclosure.
2. Wiring used for external connections shall be rated at least 20K higher than the maximum ambient temperature.

### 10.8.4 Marking

#### For OLCT-100-XP

Class I, Div. 1, Groups A, B, C & D, T6;

Ex db IIC T6 Gb;

Class I, Zone 1 AEx db IIC T6 Gb

#### For OLCT-100-IS

Class I, Div. 1, Groups A, B, C & D, T4;

Ex ia IIC T4 Ga;

Class I, Zone 0 AEx ia IIC T4 Ga

## 10.8.5 Standards

CAN/CSA-C22.2 No. 61010-1-12

UL Std. No. 61010-1 3rd Ed.

CSA-C22.2 No. 30: 2020

UL 1203: 2020

CAN/C22.2 No. 60079-0, 6th Ed.: 2015

UL 60079-0: 6th Ed.: 2013

CAN/CSA-C22.2 No. 60079-1, Ed. 7: 2016

UL 60079-1 Ed. 7: 2015

CAN/CSA-C22.2 No. 60079-11, 6th Ed.: 2014

UL 60079-11, 6th Ed.

CAN/CSA-C22.2 No. 60079-29-1 Ed. 2: 2017

UL 60079-29-1 Ed. 2

# 10.9 Installation Drawing for OLCT100IS

## OLCT 100 IS Toxic Gas detector Commercial references : OLCT100-IS-\*

**DRAFT2**

### NON HAZARDOUS LOCATION

**Notes**

1. The maximum unclassified location voltage  $U_m$  is 250 V AC/DC for satisfying the safety of the I.S. system.
2. J2 connector provides intrinsically safe circuits for connection with any I.S. certified devices for use in explosive atmospheres of group IIC or IIC and with entity parameters that satisfy the conditions in Note 4 ; this device must not take the form of a voltage generator or a current generator.

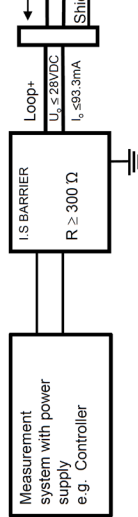

3. Make all intrinsically safe wiring connections per applicable local and international electrical codes.

4. For the Entity Concept use the appropriate parameters to ensure the following conditions:

$$U_0 \leq U_i$$

$$I_0 \leq I_i$$

$$C_0 \geq C_i + C_{cable}$$

$$L_0 \geq L_i + L_{cable}$$

5. External devices shall be installed per the manufacturers installations instructions.
6. WARNING: substitution of components may impair intrinsic safety.

### HAZARDOUS LOCATION -40°C ≤ Tamb ≤ +70°C

Americas  
Class I, Div 1, Group A,B,C,D  
Class II, Zone 1 Group IIC  
IECEVA/TEX  
Zone 1 Group IIC  
Zone 21, Group IIC

Aluminium enclosure



J3 input connector  
J2 : output connector  
(measurement with an I.S. multimeter)

Cable Parameters:  $C_{cable}$ ,  $L_{cable}$

Stainless steel enclosure



Americas  
Class I, Div 1, Group A,B,C,D  
Class II, Zone 0, Group IIC  
IECEVA/TEX  
Zone 0, Group IIC  
Zone 20, Group IIC

#### J3 Input Entity Parameters (note 4)

$$U_i = 28 \text{ VDC}$$

$$I_i = 93.3 \text{ mA}$$

$$C_i = 39.5 \text{ nF}$$

$$L_i = 0 \text{ H}$$

#### J2 Output Entity Parameters (note 2)

$$U_o = 28 \text{ V}$$

$$I_o = 93.3 \text{ mA}$$

$$C_o = 44 \text{ nF}$$

$$L_o = 3.5 \text{ mH}$$

B	08/12/2023	CABANNES	Architecture update, many minor update
A	10/09/2012	CHEVALIER	First issue
Rev	Date	Emitteur	Signature
Dimensions : dimensions Ex doivent être contrôlées à 100% / Ex dimensions here to be checked at 100%			
Matière : MATIÈRE TRAITEMENT : 1			
TOL. GEN	Etats Surf. : 0, 8	OLCT 100 IS CONTROL DRAWING	
150 2 768m	100 (100)	interconnections between intrinsically safe and associated apparatus.	
Revue	STH	N° PLAN	REV
Multification	ADG	21738GA	B
Approbateur	IGCS	Poids	
		Echelle	X: X PAGE 1 OF 1
© 2023, Teledyne Technologies Incorporated. All rights reserved.			
Use and Disclosure of Data: Information contained herein is uncontrolled under the E.U. Regulation (EC) No 2021/821 and/or E.U. Member State regulation. Export, reexport or diversion contrary to law is prohibited.			



## 10.10 Scope of use

Gas sensors have certain limitations; it is essential to fully recognize these limitations (see Chapter 9).

### 10.10.1 Presence of specific components

- Vapour from silicone or sulphur-containing components can affect the catalytic gas detector sensors and thereby distort the measurements. If the sensors have been exposed to these types of compounds, an inspection or calibration will become necessary.
- High concentrations of organic solvents (e.g. alcohols, aromatic solvents, etc.) or exposure to quantities of gas greater than the specified range of measurement can damage the electrochemical sensors. Inspection or calibration is then recommended.
- In the presence of high concentrations of carbon dioxide ( $\text{CO}_2 > 1\%$  vol.), the oxygen-measuring electrochemical sensors can slightly overestimate the concentration of oxygen (0.1 to 0.5%  $\text{O}_2$  overestimate).

### 10.10.2 Operation under low oxygen levels

- If an electrochemical detector sensor is used in an atmosphere comprising less than 1% oxygen for over one hour, the measurement may be an underestimate.
- If a semiconductor detector sensor is used in an atmosphere comprising less than 10% oxygen, the measurement may be an underestimate.
- If a semiconductor detector sensor is used in an atmosphere comprising less than 18% oxygen, the measurement may be an underestimate.
- If a MEMS detector sensor is used in an atmosphere comprising less than 15% oxygen, the measurement may be an underestimate (15% Vol. of oxygen in air gives a reading of -5% LEL, 5% Vol. of oxygen in air gives a reading of -12% LEL).

## 10.11 Functional safety

The detector is certified by INERIS to be in conformity with SIL capability 2. Applicable since 2005, this standard is concerned with electrical apparatuses for the detection and measurement of oxygen or toxic or flammable gases or vapors, and defines the requirements relating to the safety function of fixed gas detection systems.

The detector has been developed in conformity with standard EN/CEI 61508 and EN50402.

The safety function of the OLC/OLCT 100 detector is the detection of flammable gases using catalytic technology and a 4-20 mA current output proportional to the gas concentration expressed as a percentage of LEL, respectively from 0 to 100% LEL. In the event of failure, the current will assume a fall-back value less than or equal to 1 mA or greater than or equal to 23 mA.

The safety function is no longer valid:

- After power has been switched on, while the measurement sensor is stabilizing and during start-up tests, the analog output shall be in maintenance mode (2 mA).
- When the push button is pressed (forcing the current to 4 mA), the output current will be frozen at 4 mA.

## 10.12 Reliability data

These data are based on feedback from experience in the field. The analysis of the information recorded during maintenance by our technical team has enabled us to determine the following Probabilities of Failure on Demand under normal conditions of use:

Type of gas	Measurement principle	SIL Capability	$\lambda$ DU	PFD AVG	Test period	SFF
LEL	Catalytic (VQ1)	SIL 2	$1,89 \cdot 10^{-7}$	$8,9 \cdot 10^{-4}$	12 months	92,9%
Oxygen <sup>(*)</sup>	Electrochemical	SIL 2	$3,4 \cdot 10^{-7}$	$7,6 \cdot 10^{-4}$	6 months	94,4%

*(\*) Software and hardware according to INERIS certificate. Sensors data according to proven in use.*

MTR: 24h

## 10.13 Special conditions of use



In case of exposure above the measuring range, it is mandatory to bump test the instrument with gas and/or to perform a calibration.

In the event of a change of position, it is necessary to re-calibrate the detector.

# 11 Appendix Ordering information

## 11.1 Gas List

Please find below the list of gases that the OLC/OLCT 100 detector can detect.

Gas Code	Gas
001	Methane 0-100 % LEL
002	Methane 0-100% LEL (4.4% vol)
003	Hydrogen 0-100% LEL
004	Butane 0-100% LEL
005	Propane 0-100% LEL
006	Ammoniac 0-100% LEL
007	Ethyl Acetate 0-100% LEL
008	Butyl Acetate 0-100% LEL
009	Methyl acetate methyle 0-100% LEL
010	Acetone 0-100% LEL
011	Acetonitrile 0-100% LEL
012	Acetylene 0-100% LEL
013	Acrylic acid 0-100% LEL
014	Acroleine 0-100% LEL
015	Butyl acrylate 0-100% LEL
016	Ethyl Acrylate 0-100% LEL
017	Acrylonitrile 0-100% LEL
018	Benzene 0-100% LEL
019	1.3-Butadiene 0-100% LEL
020	Butanol (isobutanol) 0-100% LEL
021	2-Butanone 0-100% LEL
022	Cumene 0-100% LEL
023	Cyclohexane 0-100% LEL
024	Cyclohexanone 0-100% LEL
025	Dimethylether 0-100% LEL
026	Dodecane 0-100% LEL
027	Ethane 0-100% LEL
028	Ethanol 0-100% LEL
029	Ether (diethylether) 0-100% LEL
030	Ethylene 0-100% LEL
031	Formaldehyde 0-100% LEL
032	LPG 0-100% LEL
033	Diesel 0-100% LEL
034	Natural gas 0-100% LEL
035	Heptane 0-100 % LEL

# OLC/OLCT100

GAS DETECTOR  
USER MANUAL

Gas Code	Gas
036	Hexane 0-100% LEL
038	Isobutane 0-100% LEL
039	Isobutene 0-100% LEL
040	Isopropanol 0-100% LEL
041	Kerosene (JP4) 0-100% LEL
042	Methyl Methacrylate 0-100% LEL
043	Methanol 0-100% LEL
044	Methylamine 0-100% LEL
045	Naphta 0-100% LEL
046	Naphtalene 0-100% LEL
047	Nonane 0-100% LEL
048	Octane 0-100% LEL
049	Ethylene Oxide (epoxyethane) 0-100% LEL
050	Propylene Oxide (Epoxypropane) 0-100% LEL
051	Pentane 0-100% LEL
052	Propylene 0-100% LEL
054	Styrene 0-100% LEL
055	Gasoline Lead free 0-100% LEL
056	Toluene 0-100% LEL
057	Trimethylamine 0-100% LEL
058	White spirit 0-100% LEL
059	Xylene 0-100% LEL
064	MIBK 0-100% LEL
065	R1234yf 0-100% LEL
066	DMA 0-100% LEL
068	Chloroethane 0-100% LEL
070	Chloromethane, 0-100% LEL
072	Cyclopentane 0-100% LEL
074	Allyl alcohol 0-100% LEL
075	R1234ze 0-100% LEL
078	R454b 0-100% LEL
200	Oxygen O <sub>2</sub> (electrochemical) 0-30% vol (life expectancy 2 years)
272	Oxygen O <sub>2</sub> (electrochemical) 0-30% vol (life expectancy 5 years)
282	Oxygen O <sub>2</sub> (electrochemical) 0-10% vol (life expectancy 5 years)
203	CO, 0-100 ppm
204	CO, 0-300 ppm
205	CO, 0-1,000 ppm
213	H <sub>2</sub> S, 0-30 ppm
214	H <sub>2</sub> S, 0-100 ppm
215	H <sub>2</sub> S, 0-1,000 ppm
249	H <sub>2</sub> S, 0-5000 ppm
216	NO, 0-100 ppm

Gas Code	Gas
217	NO, 0-300 ppm
218	NO, 0-1,000 ppm
219	NO <sub>2</sub> , 0-10 ppm
220	NO <sub>2</sub> , 0-30 ppm
221	SO <sub>2</sub> , 0-10 ppm
222	SO <sub>2</sub> , 0-30 ppm
223	SO <sub>2</sub> , 0-100 ppm
224	Cl <sub>2</sub> , 0-10 ppm
259	Cl <sub>2</sub> , 0-20 ppm
225	H <sub>2</sub> , 0-2,000 ppm
268	H <sub>2</sub> , 0-4% volume
227	HCl, 0-30 ppm
228	HCl, 0-100 ppm
229	HCN, 0-10 ppm
230	HCN, 0-30 ppm
231	NH <sub>3</sub> , 0-100 ppm
273	NH <sub>3</sub> , 0-300 ppm
232	NH <sub>3</sub> , 0-1,000 ppm
265	NH <sub>3</sub> , 0-1,000 ppm (low temperature -40°C)
233	NH <sub>3</sub> , 0-5,000 ppm
235	ClO <sub>2</sub> , 0-3 ppm
252	CO <sub>2</sub> , 0-5,000 ppm
239	CO <sub>2</sub> , 0-5%
240	CO <sub>2</sub> , 0-10 % volume
241	CO <sub>2</sub> , 0-100 % volume
242	PH <sub>3</sub> , 0-1 ppm
243	AsH <sub>3</sub> , 0-1 ppm
244	ETO, 0-30 ppm
245	SiH <sub>4</sub> , 0-50 ppm
246	COCl <sub>2</sub> , 0-1 ppm
247	Formaldehyde, 0-50 ppm
270	Formaldehyde, 0-150 ppm
248	ETO, 0-100 ppm
250	Methanol, 0-1,000 ppm
286	N <sub>2</sub> H <sub>4</sub> , 0-2 ppm
253	Ethyl Mercaptant, 0-100 ppm
254	Dimethyl sulfide, 0-100 ppm
261	CH <sub>4</sub> S, 0-100 ppm
500	R12, 0-1% volume
501	R22, 0-2,000 ppm
502	R134a, 0-2,000 ppm
505	R11, 0-1% volume

# OLC/OLCT100

GAS DETECTOR  
USER MANUAL

Gas Code	Gas
506	R23, 0-1% volume
507	Dichloromethane, 0-500 ppm
508	Chloromethane (Methylchloride), 0-500 ppm
509	R123, 0-2,000 ppm
510	FX56, 0-2,000 ppm
511	R143a, 0-2,000 ppm
512	R404a, 0-2,000 ppm
513	R507, 0-2,000 ppm
514	R410a, 0-1,000 ppm
515	R32, 0-1,000 ppm
517	R407c, 0-1,000 ppm
518	R408a, 0-4,000 ppm
519	R407f, 0-1,000ppm
520	R434A, 0-4000ppm
521	R245FA, 0-1000ppm
523	R407A, 0-1000ppm
524	R422D, 0-4000ppm
525	R1234ZE, 0-1000ppm
533	R1234ZE, 0-2000ppm
534	R452A, 0-2000ppm
662	R1234YF, 0-1000 ppm
526	R1234YF, 0-2000ppm
532	R1233ZD, 0-5000ppm
528	R407f, 0-2,000ppm
529	R449, 0-2000ppm
531	R32, 0-2000ppm
527	SF <sub>6</sub> , 0-2,000ppm
656	Ethanol, 0-500 ppm
657	Toluene, 0- 500 ppm
658	Isopropanol, 0-500 ppm
659	2-Butanone (MEK), 0-500 ppm
660	Xylene, 0-500 ppm
661	Styrene, 0-500 ppm
663	Benzene, 0-500ppm
MS1	Flamable gases, 0-100% LEL (ISO)
MS2	Flamable gases, 0-100% LEL (IEC)

To know your part number, please follow these instructions:

The reference is broken down as follows:

**OLCT100-XPIR-001-1**

OLCT 100 XP IR Transmitter, 0-100% LEL CH4, ATEX, M20 cable entry

Range :	Type :	Gas :	Approval and entry of cable range
OLC100	XP	Codified from 1 to 999,	1 – ATEX and M20 cable entry - Aluminum
OLCT100	IS	Includes gas and detection	3 - ATEX and ¾NPT cable entry - Aluminum
OLCT100HT5*	XPIR	range	5 – ATEX and M20 cable entry – Stainless steel
OLCT100HT10*	XPA		7 - ATEX and ¾NPT cable entry – Stainless steel
OLCT100HT15*			

\* Sensor movable up to 5, 10 or 15 meters using a high temperature cable



**TELEDYNE**  
**OLDHAM SIMTRONICS**  
Everywhereyoulook™



**AMERICAS**

14880 Skinner Rd  
Cypress  
TX 77429,  
USA  
Tel.: +1-713-559-9200

**EMEA**

Rue Orfila  
Z.I. Est – CS 20417  
62027 ARRAS Cedex,  
FRANCE  
Tel.: +33 (0)3 21 60 80 80

**ASIA PACIFIC**

Room 04, 9th Floor, 275  
Ruiping Road, Xuhui District  
SHANGHAI  
CHINA  
TGFD\_APAC@Teledyne.co  
m

[www.teledynegasandflamedetection.com](http://www.teledynegasandflamedetection.com)



© 2024 TELEDYNE OLDHAM SIMTRONICS. All right reserved.

NPO100GB Revision P.1 / June 2024